

[Next>](#)



# Guidelines for Developing and Evaluating Tree Ordinances

<http://www.isa-arbor.com/tree-ord/>

PDF version Oct 31, 2001

## Site Map

---

Major funding for this web site is provided by the USDA Forest Service through the National Urban and Community Forestry Advisory Council and the International Society of Arboriculture.

---

[About this site](#)

[How to use this site](#)

## [Part 1. Planning for an ordinance](#)

- [Types of ordinances](#)
- [Effectiveness of existing ordinances](#)
- [Developing a community forest management strategy](#)
  - [How to develop a management strategy](#)
    - [What do you have?](#)
      - Step A. Assess the tree resource
      - Step B. Review tree management practices
    - [What do you want?](#)
      - Step C. Identify needs
      - Step D. Establish goals
    - [How do you get what you want?](#)
      - Step E. Select tools and formulate the management strategy
      - Step F. Implement the management strategy
    - [Are you getting what you want?](#)
      - Step G. Evaluate and revise
- [Goals for community forest programs](#)

## Part 2. Drafting an ordinance

- [Basic ordinance provisions](#)
- [Ordinance provisions for specific goals](#)
- [View or solar access ordinance provisions](#)

## Part 3. Evaluating the urban forest and ordinance performance

### Methods for evaluating tree ordinances and the urban forest ecosystem

- [Sampling from populations](#)
  - Statistical bias
  - Random sampling and random numbers
  - Stratified sampling
  - Sample size
  - Links to sample size calculators
- [Photogrammetry and remote sensing techniques](#)
  - Uses
  - Materials needed
  - Notes
  - Sampling considerations for photogrammetry
  - Estimating tree canopy cover from aerial images
    - Visual (ocular) method for estimating canopy cover
    - Dot grid method of canopy estimation
      - [Determining sample size for dot grid estimates](#)
      - Evaluation example: *Overall canopy estimates in permanent plots*
    - Line intercept or transect method
    - Digital image analysis methods
      - [Comparison of image analysis and dot grids for calculating tree canopy cover](#)
  - Other resources
- [Ground survey](#)
  - Uses
  - Materials needed
  - Notes
  - Sampling considerations for ground surveys
  - The windshield survey
    - Evaluation example: *Windshield survey for tree topping incidence*
  - The foot survey
    - Tree size
      - [Evaluation example: Measurement of canopy cover at the edge of pavement](#)
      - [Evaluation example: Evaluating parking lot shading](#)
      - [Simplified guide to measuring DBH](#)
    - Tree condition/health
    - Proximity to infrastructure and hardscape damage

- Rating scales
- [Photo points](#)
  - Uses
  - Materials needed
  - Notes
  - Ground level photo point
  - Aerial photo points
- [Record keeping and analysis](#)
  - Uses
  - Materials needed
  - Notes
  - Geographic Information Systems (GIS)
    - Evaluation example: *Creating a forest/tree GIS*
    - [Evaluation example: CITYgreen software for ArcView GIS](#)
  - Tree inventory systems
    - Additional resources
    - Evaluation example: *Street tree inventory as part of a citywide GIS*
    - Evaluation example: *Street tree management*
  - Inventorying regulated private trees
- [Public polling](#)
  - Uses
  - Materials needed
  - Notes
  - Interviews
  - Self-completed questionnaires
  - Survey design considerations
  - Sampling considerations for public polling
  - Evaluation example: *Homeowner attitudes toward trees*

## Special Topics:

- [Defining special trees: heritage, historic, and landmark trees](#)
- [Definitions: Tree banks and tree banking](#)
- [Concepts: Mitigating for tree loss](#)

## Literature Cited

## Additional References

- General
- Dot grid estimation
- Public Polling



## About this site

---

This site provides a variety of tools and resources for citizens and local governments interested in developing, revising, or evaluating local tree ordinances. Rather than using a “model ordinance” approach, we describe how tree ordinance development can be integrated with an overall community tree management program. The site includes annotated examples of effective tree ordinance provisions used throughout the country. We also provide detailed descriptions of practical methods used to monitor community tree resources, tree management activities, and community attitudes.

Support for the development and support of this site is provided by grants from the [U.S.D.A. Forest Service](#) through the [National Urban and Community Forestry Advisory Council](#) 1999 Challenge Cost-Share Grant Program, the [International Society of Arboriculture](#), and [ESRI, Inc.](#), and in-kind contributions from:

[Phytosphere Research](#)  
[American Forests](#)  
[Society of Municipal Arborists \(SMA\)](#)  
[International City Management Association \(ICMA\)](#)  
[National Association of State Foresters \(NASF\)](#)  
[Alliance for Community Trees \(ACT\)](#)  
[California ReLeaf](#)  
[American Planning Association](#)

This content of this site was produced by Elizabeth A. Bernhardt and Tedmund J. Swiecki of Phytosphere Research, Vacaville, CA. It is based on the publication **Guidelines for Developing and Evaluating Tree Ordinances** (Bernhardt and Swiecki 1991). The original report was prepared for the California Department of Forestry and Fire Protection, [Urban Forestry Program](#). A complete version of the original publication in Adobe Acrobat PDF format can be downloaded from the CalPoly [Urban Forest Ecosystems Institute](#) site.

The purpose of this site is to provide practical information for communities dealing with tree ordinances and other urban forest management issues. We also hope to provide a means for sharing successful ordinance provisions and urban forest evaluation and monitoring methods used in cities and counties throughout the country. If you have material that you would like to submit for possible inclusion in the site, please [e-mail Phytosphere Research](#). You may also contact us by phone (707-452-8735, 9-5 pm Pacific time) or mail (Phytosphere Research, 1027 Davis Street, Vacaville, CA 95687).

---

# How to use this site

Whether a community is large or small, rural or urban, in a natural forest or in the desert, the basic process for developing a tree ordinance is the same. In each case, the community needs to determine what it has to work with and what it hopes to achieve. It must then formulate and execute plans to get what it wants, and finally, evaluate whether it is achieving its desired ends. The information in this web site is intended to guide you through this process.

The process we recommend for developing or revising a tree ordinance is outlined in [Part 1](#). Following the process in Part 1 will help you determine whether you actually need to develop or revise a tree ordinance. It also describes the importance of setting definite goals in the development of a tree ordinance. After reviewing the material in Part 1, you will be better able to effectively use the remaining sections of this site.

Part 2 is a guide to drafting an ordinance. It shows how to select specific ordinance provisions to meet the tree management goals set by your community. Please note that this section does not present a "model" ordinance. Instead, it is a listing of provisions from various tree ordinances that can be used to help achieve specific goals. Individual ordinance provisions are presented and explained, and example text is provided. Using the input of local citizens, your community can select provisions and develop language that will yield an ordinance that is uniquely suited to its own needs and desires.

How can you determine if your tree ordinance is working? Part 3 is a technical guide to methods which can be used to evaluate and monitor the effectiveness of ordinance provisions. Many of the evaluation methods described in this section may also be employed in the process of ordinance development described in Part 1.

This site is designed to be used by either citizen groups or local governments. However, development of a tree ordinance will be most effective when both groups work together. Some communities have found that forming a task force is an excellent way of ensuring cooperation between groups with diverse interests.



## Part 1. Planning for an ordinance

---

More and more communities are beginning to recognize the very tangible benefits that trees provide in the urban environment. Healthy trees reduce air and noise pollution, provide energy-saving shade and cooling, furnish habitat for wildlife, enhance aesthetics and property values, and are an important contributor to community image, pride, and quality of life. Furthermore, many communities have realized that in order to protect and enhance their valuable tree resources, it is useful to view and manage their trees as a cohesive unit, the *community* or *urban forest*.

Tree ordinances are among the tools used by communities striving to attain a healthy, vigorous, and well-managed community forest. By themselves, however, tree ordinances cannot assure that the trees in and around our communities will be improved or even maintained. Tree ordinances simply provide the authorization and standards for management activities. If these activities are not integrated into an overall management strategy, problems are likely to arise. Without an overall strategy, management will be haphazard, inefficient, and ineffective, and the community forest will suffer.

This larger management view is commonly lacking when ordinances are developed. Local ordinances are often developed in response to public outcry over specific perceived problems. This "band-aid" approach frequently leads to ordinances that are not consistent with sound community forest management, and may in fact thwart good management efforts. For example, public outcry has led to the development of many ordinances designed to protect old "heritage" trees. Unfortunately, most of these same ordinances allow the routine destruction of younger trees. The end result may be an unsustainable community forest, short on young trees and long on old, declining trees. By focusing too narrowly on individual trees, such ordinances may contribute to the degradation of the community forest over the long term.

A tree ordinance is not a panacea for poor or inadequate municipal tree management. Nor is it a replacement for a comprehensive community forestry program that is fully supported by the local government and community residents. Properly applied, tree ordinances can facilitate good management of community tree resources. Improperly applied, ordinances can legitimize counterproductive practices and undermine the long term success of the community forest.

### **Types of ordinances**

In 1990, we conducted a study of city and county tree ordinances in California ([Bernhardt and Swiecki 1991](#)). We reviewed 159 enacted city tree ordinances and 9 enacted county ordinances in addition to a small number of proposed ordinances. This sample represented about 50% of the city tree ordinances and 80% of the county tree ordinances in effect in California at that time.

For the purposes of our review, we grouped tree ordinances into three basic categories:

- **Street tree ordinances** primarily cover the planting and removal of trees within public rights-of-way. They often contain provisions governing maintenance or removal of private trees which pose a hazard to the traveling public. Also included in this category are ordinances with tree planting requirements, such as those requiring tree planting in parking lots.
- **Tree protection ordinances** are primarily directed at providing protection for native trees or trees with historical significance. They usually require that a permit be obtained before protected trees can be removed, encroached upon, or in some cases, pruned.
- **View ordinances** are designed to help resolve conflicts between property owners that result when trees block views or sunlight.

Among California cities, street tree ordinances were more common than tree protection ordinances, although many city ordinances include elements of both. County tree ordinances were most commonly tree protection ordinances, and most of these regulated tree removal on private property. View ordinances were relatively uncommon. We received view ordinances from only four cities and one county. Most of these were "self-enforcing", that is, they set forth a procedure through which private parties could resolve conflicts without direct intervention by the city or county.

Although other types of ordinances, such as grading ordinances, may be related to trees and other vegetation, our discussion will be limited to these three categories, which encompass the overwhelming majority of all tree-related local ordinances.

## **Effectiveness of existing ordinances**

The effectiveness of a tree ordinance can be influenced by many factors. Do the residents support or oppose various ordinance provisions, or are they even aware of them? Is the ordinance enforced adequately? Does the ordinance account for environmental limitations that affect tree health, growth, and survival? Does the local government have the financial resources to fulfill ordinance requirements? Since the answers to these questions will vary from place to place, even very similar ordinances can have quite different outcomes in different communities.

In our 1992 survey of city and county tree programs in California ([Bernhardt and Swiecki 1993](#)), we asked tree program managers about the effectiveness of their existing ordinances. The majority of respondents from cities and counties with existing ordinances believed that their current tree ordinance was in need of revision. In some cases, respondents from different programs within the same city had widely divergent opinions on the effectiveness of their existing ordinance. Enforcement was not the only issue affecting effectiveness ratings - 52% of the city respondents felt that tree ordinance enforcement was adequate. (A note of caution here: many of these respondents were probably responsible for ordinance enforcement in their cities.)

As we discuss in Part 3, [Evaluating the urban forest and ordinance performance](#), it is possible to objectively assess the performance of a tree ordinance. This assessment requires both an evaluation of the ordinance and related regulations and evaluation of the urban forest itself. In our analysis of California tree ordinances, we looked to see whether each ordinance had the structural elements necessary for effectiveness. Although ordinances may vary widely in form, content, and complexity, an effective tree ordinance should meet the following criteria:

1. **Goals** should be clearly stated and ordinance provisions should address the stated goals.

2. **Responsibility** should be designated, and authority granted commensurate with responsibility.
3. **Basic performance standards** should be set.
4. **Flexibility** should be designed into the ordinance.
5. **Enforcement** methods should be specified.
6. The ordinance should be developed as part of a **comprehensive management strategy**.
7. The ordinance should be developed with **community support**.

The first five criteria are key features of the ordinance itself. The last two criteria reflect the background in which the ordinance is developed. Although an ordinance meeting these criteria is not guaranteed success, ordinances lacking one or more of these elements will definitely be handicapped. In our review of city and county tree ordinances, we looked for evidence that the first six of these basic criteria were met.

## Goals

A clear statement of goals is essential, since goals provide the basis for interpreting the ordinance and evaluating its effectiveness. However, only 52% (88) of the ordinances we reviewed began with a stated purpose which can be interpreted as the goal of the ordinance. Goals were most commonly lacking in street tree ordinances. Among street tree ordinances that did list a goal, it was often of the form, "*to establish rules and regulations governing tree planting, maintenance and removal on the public right of way*". This type of goal suggests that the ordinance is seen as an end in itself, rather than as a tool to help achieve certain community forestry goals. Some street tree ordinances do show a clear link with a wider management strategy, as indicated by a goal such as "*to create a master plan governing tree planting, maintenance, and removal*".

Tree protection ordinances nearly always begin with a stated goal, such as "*to prevent wanton destruction of trees*", or "*to preserve as many trees as possible during the development process*". However, goals such as these may be too general to allow for meaningful evaluation. How many are "as many as possible"? The lack of clear, specific goals is a common shortcoming of many tree ordinances.

## Responsibility and authority

Of the ordinances reviewed, 54% (91) designated a single position responsible for enforcing the ordinance and carrying out the urban forest program. In the remainder of the ordinances, responsibility was split between two or more positions, or worse yet, was not designated.

In most cases, the most efficient way to manage the urban forest is to have a single person responsible for overseeing all tree-related activities. This allows for better coordination of management activities and reduces conflicts between departments. However, in small communities, it may not be possible to have a single central tree authority. Responsibility may be split between a tree commission, which sets policy and has administrative duties, and city staff, which is responsible for operations and enforcement.



The tree program manager should be vested with the authority necessary to carry out his or her responsibilities. A reasonably clear link between responsibility and authority is found in many tree ordinances. However, in some ordinances, responsibility appears to exceed authority, whereas in others, authority is granted, but specific responsibilities are not stated. The management of the urban forest is likely to suffer when responsibilities are ill-defined or the authority to act is not granted.

## Basic performance standards

Many tree ordinances focus on setting specific standards that pertain to trees. A tree ordinance should indicate which practices and conditions are acceptable and which are not. For example, damaging public trees is unacceptable in most communities and is addressed in many tree ordinances. Some communities find that damage to or removal of oaks and other native trees without cause is unacceptable, and address this in their ordinances.

Besides stating what is regulated, an ordinance should set basic standards for performance. Many older ordinances are deficient in this regard. For instance, many ordinances require tree planting in conjunction with new construction. However, relatively few ordinances set standards for the eventual amount of canopy cover or shading that is to be provided, or the level of species diversity to be achieved. Similarly, many ordinances require an extensive permit process before native trees can be removed, but few set a standard for the maximum amount of canopy that can be removed overall. If basic standards for performance are not set, it is possible that all individual actions taken will conform with the ordinance, but that the overall goals of the ordinance are never achieved. Effective performance standards address the urban forest as a whole rather than focusing exclusively on individual trees.

Excessively vague standards (e.g., "as much as possible") may not only be unenforceable, but may not survive a legal challenge. In 1999, a Fulton County Superior Court Judge ruled in favor of developer against the City of Atlanta because a section of the city's tree ordinance lacked sufficient objective standards. The section in question included the following language (underlined sections are our emphasis):

*...the city arborist shall require that improvements be located so as to result in minimal disturbance to the natural topography of the site and the protection of the maximum number of mature trees on the site. It is the specific intent of this section to require that damage to mature trees located within setback and required yard areas and to trees located on abutting properties owned by others be minimized to the greatest degree possible under the particular circumstances, as determined by the city arborist in the city arborist's discretion.*

[Atlanta, GA: 1999 Code of Ordinances Part II, Ch. 158, Art. II, Div. 2, Sec. 158-104]

Although the concept advanced in this provision may be reasonable, additional language is needed to more clearly define what constitutes "minimum disturbance" or the "maximum number". For example, tree retention standards based on a percentage of the existing tree density or canopy cover (see [Provision 32. Conservation of forest and woodland resources during development](#)) could provide a sufficiently objective standard for assessing whether a project complies with the ordinance.

While avoiding the pitfall of vagueness, an ordinance should also avoid slipping into the abyss of excessive technical detail. Many ordinances have focused on very detailed implementation standards instead of setting basic performance standards. For example, many ordinances include lists of species that are allowed or prohibited for use as street trees. Others specify the size of planting stock to be used in plantings. Implementation standards such as these change as new methods and materials are developed and old ones fall out of favor, and as a result, ordinances with these details can quickly become outdated. If detailed specifications are needed, they are more appropriately placed in the urban forest management plan, which can and should be updated frequently.

## **Flexibility**

While ordinances should set basic performance standards, it is important that they allow for flexibility. If the tree ordinance sets objective performance standards, it can also direct the community arborist or forester to implement the standards by making decisions on a case-by-case basis. This can reduce the need for overly detailed implementation standards and allows for the flexibility to make decisions based on site-specific physical and biological factors. Even if a community does not have personnel with the necessary expertise on staff, the ordinance can allow for the input of qualified professionals on specific issues. For example, many tree protection ordinances require a report by a qualified consultant as a part of the permit process. Outside technical consultants should work for and be responsible for representing the interests of the community, not clients that may have a financial interest tied to tree removal or damage (e.g., a property owner or developer).

About three-quarters of the ordinances have a process for appealing decisions. The appeal process provides a degree of flexibility, in that it serves as a check against the authority of the tree program manager. Ideally, this helps to ensure that decisions are based on all pertinent information, and that they stand on technical merit. Unfortunately, appeals may also serve to undermine good urban forest management if they routinely allow political pressure to override the decisions of competent tree specialists.

## **Enforcement**

Enforcement is an important aspect of every ordinance. Only slightly more than half of the ordinances we received contain an enforcement element. Although 48% (81) of the ordinances specified penalties for violations, only 24% (41) designated a position or positions responsible for enforcement. Thus, many tree ordinance provisions may not be enforced because nobody is specifically charged with this duty.

In ordinances with enforcement provisions, many kinds of penalties are employed. Fines, jail terms, and forfeiture of performance bonds are among the penalties invoked in both street tree and tree protection ordinances. Many jurisdictions also require specific replacement plantings as penalties. In some street tree ordinances, occupancy permits are withheld until required trees and landscaping are satisfactorily installed. Many of the penalties available appear to be sufficient to help deter offenders, but only if consistent enforcement makes it likely that violators will be cited and penalized.

## **Comprehensive management strategy**

Few existing ordinances have been developed as part of an integrated tree management strategy. Only 6% (10) of the Californian ordinances we reviewed showed clear evidence that they were an element of a comprehensive management strategy. Without this underlying strategy to guide the process, inappropriate provisions may be included, or necessary provisions may be omitted. Furthermore, local governments may unsuccessfully use a tree ordinance to pursue goals that are more readily achieved through other means. The tree ordinance is often seen as an end in itself, rather than as one of a number of tools which must be used to

attain a healthy, vigorous, and well-managed community forest. The lack of integration between urban forest management and tree ordinances is probably the most prevalent and serious problem with tree ordinances overall.

An ordinance is not a panacea for poor or inadequate management of community tree resources. Properly applied, an ordinance can help facilitate good management. Improperly applied, ordinances can legitimize counterproductive practices, provide disincentives for tree conservation, and undermine the long-term sustainability of the urban forest. By focusing on community forest management, rather than simply regulation, communities can determine whether an ordinance is necessary, and what its role should be. By following the process we present, [Developing a Community Forest Management Strategy](#), communities can develop effective ordinances that are uniquely suited to meet their specific needs.

It seems that relatively few communities have followed this approach in developing their tree ordinances. Far more commonly, tree ordinances are drafted after reviewing a few existing ordinances or "model" ordinances. As a result, we found that many California tree ordinances were very similar to one another. In several instances, two or more communities had identical ordinances. Certain frequently-copied provisions are found unchanged in many ordinances, often complete with dated terms or concepts. Although it is possible to construct an ordinance using a "cookie cutter" approach, such an ordinance is unlikely to be well integrated with a comprehensive urban forest management strategy.

## **Community support and ordinance success**

Community support is critical to ordinance effectiveness, but community support cannot be legislated into an ordinance. Rather, the ordinance must be developed within the context of community values and priorities if it is to enjoy public support. Even a technically correct tree ordinance is apt to be ineffective without public support.

Passing a highly restrictive ordinance in a nonsupportive community is not only politically difficult, but may be counterproductive. [Rossi \(1990\)](#) described such a situation that occurred after the passage of a tree protection ordinance. Local citizens attempted to circumvent the ordinance by cutting down trees before they attained the diameter specified for protection in the ordinance.

As a practical matter, most tree ordinances rely heavily on voluntary compliance. Few communities would support the concept of a patrolling "tree cop" that seeks out violations. However, citizens in many communities are willing to voluntarily comply with restrictions they perceive as reasonable, and report obvious violations to protect their local tree resources. To be successful, tree ordinances should not impose regulations that most local citizens are unwilling to support.

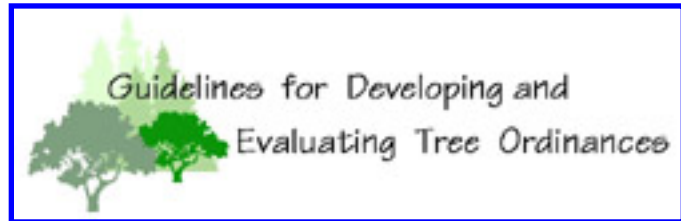

## Developing a community forest management strategy

---

Many community tree ordinances have been developed in response to public outcry over specific perceived problems. Unfortunately, a "band-aid" approach to developing tree ordinances often leads to ordinances that are not consistent with sound management practices, and which can actually thwart good management. We believe that communities need to develop or review their overall urban forest management strategy before considering a new or revised tree ordinance. Policy makers must recognize that the primary goal is effective management of local tree resources, not simply regulation.

Tree ordinances provide the legal framework for successful urban forest management by enabling and authorizing management activities. However, methods for managing the urban forest ecosystem are continually evolving, and the input of trained professionals to the management process is critical. Therefore, we believe that **ordinances should facilitate rather than prescribe management.** Successful tree ordinances follow this guiding principle.

If the role of a tree ordinance is to facilitate resource management, the tree ordinance must be part of a larger community forest management strategy. Most of the shortcomings attributed to tree ordinances can usually be traced to the lack of a clearly thought-out management strategy. Poor planning leads to poor ordinances, and even the best-written ordinance is unlikely to succeed in the absence of an overall urban forest management strategy. We have found that few existing tree ordinances have been developed as part of a [comprehensive management strategy](#).

## How to develop a management strategy

We have generally followed [Miller's \(1988\)](#) model of the management planning process. More recently, the descriptive term **adaptive management** has been applied to this process. [Miller \(1988\)](#) presents the management planning process in terms of three basic questions:

- [What do you have?](#)
- [What do you want?](#)
- [How do you get what you want?](#)

Developing an appropriate tree ordinance may be a partial answer to the third question, i.e., it is one way of trying to get what you want. However, it should be clear that the first two questions need to be answered before the third can be addressed. Thus, assessment (determining what you have) and goal-setting (determining what you want) should precede any consideration of an ordinance.

In practice, answering the first two questions is often an iterative process. Communities may have ideas about what they want before they fully assess what they have. However, an assessment of existing tree resources can help point out needs that might not be obvious, and will help the community to establish appropriate goals.

Since the urban forest resource and the external factors that affect it are continually changing, developing a management strategy must be an ongoing process. Asking a fourth question helps to bring the process full circle:

- [Are you getting what you want?](#)

Miller (1988) represents this phase as a feedback step which connects the third question back to the first. If the planning process is to be effective, it is necessary to determine whether you actually achieve what you want. If not, methods for getting what you want may need to be changed. Alternatively, it is possible that what you get is no longer what you want, and goals will need to be revised as well.

We can define a number of specific steps that address each of these four basic questions. These steps have been defined in similar ways by various authors ([Lobel 1983](#), [Miller 1988](#), [Jennings 1978](#), [McPherson and Johnson 1988](#), [World Forestry Center and Morgan 1989](#)). For the purposes of our discussion, we recognize seven distinct steps which are discussed below.

Working through these steps need not be overly complicated or arduous. The entire process is driven by the specific resources and goals of the individual community. By following the process outlined below, a small community with very modest tree management goals can develop a simple ordinance that addresses its limited goals. On the other hand, communities seeking to develop a comprehensive tree management program or expand their existing programs can do so following the same process. Ordinances developed through this process will be uniquely suited to the needs of each community.

## WHAT DO YOU HAVE?

### Step A. Assess the tree resource.

An assessment of tree resources provides the basic information necessary for making management decisions. It also provides a baseline against which change can be measured. Ideally, this assessment should include all tree resources within the planning area of the municipality. However, in communities that are just starting to consider municipal tree management, an incremental approach may be more practical. In this case, the assessment may be focused on a certain portion of the urban forest, such as street trees or trees in a particular geographic area.

Tree resource assessments are based on various inventory methods, most of which require some type of survey. Complete tree inventories of all public trees are relatively common, and play a central role in many tree management programs. However, for the purposes of setting goals and initiating a management strategy, information from a representative sample of the urban forest will often suffice.

Information that may be useful for management planning includes:

- total number of trees classified by species, condition, age, size, and location;
- problem situations, such as sidewalk damage, disease and pest problems, or hazardous trees, preferably linked to the basic tree data listed above;
- amount of canopy cover by location.

Inventories vary in complexity depending on the size of the community and the nature of the data collected. They can be made by city staff, consultants, or trained volunteers. In one small community, an inventory of street trees was conducted as an Eagle Scout project. However, it is important to ensure that the data collected is valid and reliable, since this information provides a basis for decisions made in later steps in the process. Several simple sampling and evaluation techniques applicable to urban forestry are described in the [Evaluation](#) pages.

## Step B. Review tree management practices.

An important part of understanding the status of the urban forest is knowing how it has been managed. This requires information on both past and current management methods and actions, such as:

- municipal tree care practices, including planting, maintenance, and removal;
- existing ordinances, and the level of enforcement practiced (numbers of violations, permits and citations issued, penalties and fines collected);
- planning regulations and guidelines that pertain to trees, and numbers of tree-related permits granted, modified, or denied;
- activities of municipal departments and public utilities that impact trees.

The specific types of information involved will vary by jurisdiction, depending on the level of past and current tree management. Municipal records are the most reliable source of this information. However, records on maintenance or ordinance enforcement may not exist in some cases, and the information may have to be obtained by interviewing local government staff involved with these activities.

The point of this step is to identify all of the activities that affect trees in the community, especially those that are under municipal control of one form or other. For instance, various ordinances and planning regulations seemingly unrelated to the tree program may impinge on tree resources and their impact must be taken into account. Before trying to change community forest management, we need to consider both current and historical management practices and identify all of the players involved.

# WHAT DO YOU WANT?

## Step C. Identify needs.

With information on the status of their tree resources and tree management in hand, a community is in a good position to assess its urban forestry needs. Urban forestry needs can be grouped into three broad categories, although many needs may actually fall into more than one category. **Biological needs** are those that are related to the tree resource itself. Typical needs in this category include the need to:

- increase species and age diversity to provide long-term forest stability;
- provide sufficient tree planting to keep pace with urban growth and offset tree removal;
- increase the proportion of large-statured trees in the forest for greater canopy effects;
- ensure proper compatibility between trees and planting sites to reduce sidewalk damage and conflicts with overhead utilities that lead to premature tree removal.

**Management needs** refer to the needs of those involved with the short- and long-term care and maintenance of the urban forest. Some common management needs include:

- develop adequate long-term planning to ensure the sustainability of the urban forest;
- optimize the use of limited financial and personnel resources;
- increase training and education for tree program employees to ensure high quality tree care;
- coordinate tree-related activities of municipal departments.

**Community needs** are those that relate to how the public perceives and interacts with the urban forest and the local urban forest management program. Examples of community needs include:

- increase public awareness of the values and benefits associated with trees;
- promote better private tree care through better public understanding of the biological needs of trees;
- foster community support for the urban forest management program;
- promote conservation of the urban forest by focusing public attention on all tree age classes, not just large heritage trees.

The needs listed above are common to many communities. However, the specific needs of each community will vary, and may include others not noted here.

## Step D. Establish goals.

Now that we know what we have and what we need, we are ready to set goals to address local urban forestry needs and to guide the formation of the management strategy. To establish realistic goals, it's important to consider limitations posed by the level of community support, economic realities, and environmental constraints. Because of limited resources, communities may be unable to immediately address all of the needs identified. If this is the case, it will be necessary to prioritize goals. In setting priorities, it is important not to neglect goals that require a long-term approach in favor of those that can be achieved quickly.

At this point in the process, it is absolutely critical to get community involvement and support. Most tree ordinances rely heavily on voluntary compliance by the public. Such compliance is only likely to be achieved if members of the community support the goals which have been set. Management goals reached through public involvement are likely to reflect community values and therefore enjoy public support. Public participation in the goal-setting process also serves an educational function, providing an opportunity for citizens to see how urban forest management affects their community.

Goals are the tangible ends that the management strategy seeks to achieve. It is therefore important to set goals which are quantifiable in some way, so that progress toward the goals can be monitored. For example, while it is admirable to seek to "improve the quality of life" or "protect the health and welfare of the community", such goals are generally too diffuse to be measured in any meaningful way. However a goal such as "establish maximum tree cover" can be made quantifiable by setting canopy cover or tree density standards. Typical tree program goals which are consistent with good urban forest management are discussed in more detail on the [Ordinance Goals](#) page.

# HOW DO YOU GET WHAT YOU WANT?

## Step E. Select tools and formulate the management strategy.

The objective of this step is to develop a management strategy that addresses your specific goals. There are many approaches that can be used to address each goal, and the pros and cons of each approach should be considered. Feasibility, practicality, legality, and economics should be considered in selecting the appropriate management tools. Some typical tools include:

- public education programs;
- assistance and incentive programs;
- voluntary planting programs;
- mitigation guidelines;
- planning regulations and guidelines, including the general plan and specific plans;
- ordinances.

Community involvement and support continues to be important in this phase of the process. Management approaches and tools that are unacceptable to the community are unlikely to succeed. If a local government intends to push for more progressive tree management than local citizens are ready to accept, it should choose tools that will build community awareness and support, including educational and incentive programs. Your assessment of current and past [management practices](#), should provide ideas about the effectiveness of various methods that have been used in your community. Public input and comment should be sought for any new approaches that may be contemplated or developed.

In analyzing the approaches or tools that may be used, the role of the tree ordinance in the overall strategy should become clear. In some cases, ordinance provisions will be necessary to authorize various management approaches, such as establishing the position of municipal arborist, requiring the development and implementation of a community forest master plan, or mandating a program of public education. In other cases, ordinance provisions may directly provide necessary parts of the strategy, for example by outlawing destructive practices.

The provisions placed in the tree ordinance should be directly related to the goals your community has established for its community forest. As noted earlier, these provisions should designate responsibility, grant authority, and specify enforcement methods. They should set basic performance standards, yet allow for flexibility in determining how these standards can be met. You can follow [this link](#) to see our [goal-driven Guide to Drafting a Tree Ordinance](#), but be sure to read about the last two critical steps in the management process below.

## Step F. Implement the management strategy.

Although a plan may appear ideal on paper, it clearly cannot achieve anything unless implemented. This requires the commitment of resources necessary to hire personnel, enforce ordinances, run educational programs, and carry out other components of the management strategy. The number of steps involved in implementing the management strategy may differ between communities. Steps typically involved in



implementation may include:

- passing an ordinance,
- budgeting necessary funds,
- hiring a municipal forester or arborist,
- appointing a citizen tree advisory board,
- formulating a master tree management plan,
- developing public education programs.

Since a number of steps are usually involved in implementing the management strategy, it is useful to map out an implementation schedule. This time/action schedule should show the steps that are involved and the time frame within which they should be completed. Progress checks should be built into the schedule to ensure that delays or problems are detected and dealt with. These progress checks could be in the form of required progress reports to the city council or county board of supervisors. It is important to maintain a high profile for the management program during implementation to foster public interest and maintain the commitment of the local government. If interest and support dissipate before the strategy is implemented, the efforts spent to get to this point may be for naught.

## **ARE YOU GETTING WHAT YOU WANT?**

### **Step G. Evaluate and revise.**

Even a successfully implemented management strategy must be monitored to ensure that progress is being made and standards are being met. Evaluation provides the feedback necessary to determine whether the management strategy is working. Periodic evaluation also provides an opportunity to reassess the needs and goals of the community. The management strategy may need to be adjusted to reflect new or altered goals. By providing for regular evaluation as part of the management process, the need for change can be identified before a crisis develops.

If you have set quantifiable goals, evaluating progress will be a relatively straightforward process. The types of evaluation techniques you will use will vary with the goal being evaluated. The [Evaluation Methods](#) page describes a number of simple techniques that can be used to monitor ordinance effectiveness.

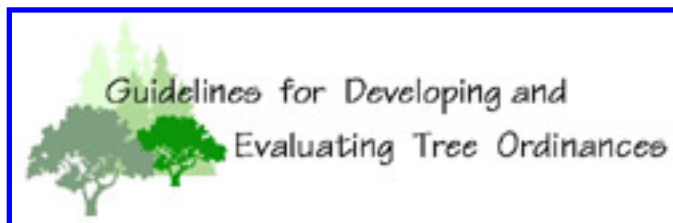

## Goals for community forest programs

---

Goals are central to developing an ordinance. Goals provide the basis for formulating and evaluating the management strategy and any tree ordinance that results from it. Thus, selecting appropriate and meaningful goals ([step D](#)) is crucial to the success of the entire process. The goals described below are consistent with good urban forest management and are typical for municipal tree programs, but this list is not comprehensive. (If you would like to see additional goals treated here, please [contact us](#).)

The goals described here are also specific enough to allow for evaluation. There is little point in establishing a goal if there is no practical way of determining whether progress is being made towards realizing that goal. To answer the management questions "[Are you getting what you want?](#)" and "[What do you have?](#)", you will need to evaluate tree resources, management activities, and public attitudes. [Evaluation methods](#) are important tools for formulating and monitoring tree management strategies and monitoring ordinance performance.

A variety of approaches can be used to help attain any given goal. You will need to decide which approaches are most appropriate for your own community. If the goal is to be addressed through a tree ordinance, one or more ordinance provisions may apply. For each goal listed below, we have included links to specific ordinance provisions that can be used to address that goal. We also describe and provide links to [evaluation methods](#) that can be used to evaluate progress towards each goal.

### Possible tree program goals:

- [1. Establish and maintain maximum tree cover.](#)
- [2. Maintain trees in a healthy condition through good cultural practices.](#)
- [3. Establish and maintain an optimal level of age and species diversity.](#)
- [4. Promote conservation of tree resources.](#)
- [5. Select, situate, and maintain street trees appropriately to maximize benefits and minimize hazard, nuisance, hardscape damage, and maintenance costs.](#)
- [6. Centralize tree management under a person with the necessary expertise.](#)
- [7. Promote efficient and cost-effective management of the urban forest.](#)
- [8. Foster community support for the local urban forestry program and encourage good tree management on privately-owned properties.](#)
- [9. Facilitate the resolution of tree-related conflicts between citizens.](#)

## 1. Establish and maintain maximum tree cover.

The urban forest serves a wide variety of functions that promote the health, safety, and general welfare of residents. These functions include:

- conserving energy, by providing shade and evaporative cooling through transpiration;
- improving local and global air quality by absorbing carbon dioxide and ozone, adsorbing particulate matter, and producing oxygen;
- reducing wind speed and directing air flow;
- reducing noise pollution;
- providing habitat for birds, small mammals, and other wildlife;
- reducing storm runoff and the potential for soil erosion;
- increasing real property values;
- enhancing visual and aesthetic qualities that attract visitors and businesses and serve as a source of community image and pride.

All these benefits increase as canopy cover increases. By establishing and maintaining maximum tree cover, the community is able to realize the maximum benefits the urban forest can provide. The maximum amount of tree canopy a given community can support must be determined by analyzing limitations posed by climate and land use.

### Ordinance provisions

Tree ordinance provisions covering planting, maintenance, and removal of trees on public and private land are related to this goal. Performance standards for the amount of tree cover the community hopes to achieve and maintain along streets, parking lots, residential and commercial areas, parks and open spaces should be established in these provisions. A provision calling for development of an urban forest management plan is essential to this goal. This plan should provide for a sustained forest canopy through properly phased tree planting and removal.

Specific provisions:

- [Designate administrative responsibilities](#)
- [Develop a comprehensive management plan](#)
- [Resolution of conflicts between trees and structures](#)
- [Planting requirements](#)
- [Permit required for activities that may damage city owned trees](#)
- [Permit required for activities that may damage protected private trees](#)
- [Conservation of forest and woodland resources during development](#)
- [Exemption from Solar Shade Control Act \(California\)](#)

### Evaluation methods

Tree canopy cover is one of the most basic and useful descriptors of the urban forest. Simply put, it is the percentage of land area covered by tree canopies. By periodically measuring canopy cover, communities can assess the effectiveness of ordinances and other management methods aimed at maintaining or increasing tree canopy.

Canopy cover can be measured directly, through [photogrammetry](#) (measurement from aerial photographs or digitized aerial images) or [ground surveys](#). These methods can be relatively easy to use, and do not necessarily require expensive equipment. Tree density, the number of trees per unit area, is indirectly related to tree canopy cover. Tree density can also be used to estimate tree cover, if the average canopy spread per tree is known. Tree density can be calculated for areas that have a complete [tree inventory](#).

## 2. Maintain trees in a healthy condition through good cultural practices.

A community is not likely to realize most of the benefits that the urban forest can provide if its trees are in poor health. Promoting tree health helps communities protect their investment in the urban forest. Public health and safety also depend on healthy trees. Improperly maintained and unhealthy trees often have an increased risk of breakage or failure, which can result in personal injury and property damage.

Cultural practices have a major impact on the health of urban trees. Proper and timely pruning can promote good tree structure and health, whereas topping and other improper pruning techniques can result in hazardous structure and decay. Irrigation is necessary for tree survival in many situations, but excess or improper irrigation practices can contribute to the decline of established trees. By providing for proper tree care and eliminating destructive practices, communities can go a long way toward maintaining their urban forests in a healthy and safe condition.

### Ordinance provisions

Tree ordinance provisions related to this goal include those that regulate tree maintenance practices (such as pruning) and prohibit or regulate various activities that may harm trees. Management of specific disease or pest problems, such as Dutch elm disease, may be facilitated by provisions that limit species selection, require removal of diseased trees, or authorize other pest management measures.

Specific provisions:

- [Designate administrative responsibilities](#)
- [Develop a comprehensive management plan](#)
- [Resolution of conflicts between trees and structures](#)
- [Help for citizens performing tree maintenance](#)
- [Topping prohibited](#)
- [Planting requirements](#)
- [Harming public trees forbidden](#)
- [Situations which are declared to be public nuisances](#)
- [Abatement of hazards and public nuisances](#)
- [Licensing of private tree care firms](#)
- [Permit required for activities that may damage city owned trees](#)
- [Permit required for activities that may damage protected private trees](#)
- [Conservation of forest and woodland resources during development](#)

### Evaluation methods

Progress toward this goal can be evaluated by assessing tree health over time through [ground surveys](#) or by [record keeping](#). [Community tree inventories](#) that include health ratings may contain all of the data necessary for evaluating progress toward this goal. Otherwise, [sample plots](#) can be established to obtain data on tree health and/or improper or prohibited cultural practices. For example, jurisdictions that prohibit topping might survey specifically to determine the incidence of this particular problem. For certain health problems affecting large areas with many trees, [remote sensing methods](#) (e.g., color infrared photos, multispectral satellite imagery) may be useful.

### **3. Establish and maintain an optimal level of age and species diversity.**

The trees that make up the urban forest have finite life spans and must be removed as they die. Living trees may also be removed when their health, appearance, or structural integrity decline substantially, or when they conflict excessively with utilities and structures. The likelihood that a tree will need to be removed for one reason or another increases as the tree grows older and larger. If areas are planted to a single species at one time, a large percentage of the trees will need to be removed over a short time period when they reach the end of their useful life. This results in a rapid reduction in canopy cover, and the loss of many of the benefits provided by the urban forest. This undesirable situation is less likely to occur if the urban forest is composed of a variety of tree age classes and species.

Serious pest outbreaks and epidemics can arise in communities in which large areas are planted to a single susceptible species or variety. These outbreaks can seriously impair the overall health, appearance, and longevity of the urban forest. Species diversity and genetic diversity within species helps stabilize the urban forest by buffering it from pest and disease epidemics. Many insect pests and plant pathogens can only attack one or a few tree species. The reproduction and spread of many tree pests and diseases will be slowed if the community forest contains a diverse mix of tree species. Furthermore, if an especially virulent disease or pest problem does develop on a given species, species diversity ensures that the condition of the entire community forest is not jeopardized.

### **Ordinance provisions**

The ordinance provisions that most directly address this goal require the development of and adherence to a complete urban forest or street tree master plan. To address this goal, the plan should provide for species diversity in new tree plantings, a significant change from single species blocks that are common in many communities. The master plan should also describe how removal and replanting throughout the community can be phased to attain a good mix of tree maturities.

Specific provisions:

- [Designate administrative responsibilities](#)
- [Develop a comprehensive management plan](#)
- [Planting requirements](#)
- [Conservation of forest and woodland resources during development](#)

### **Evaluation methods**

In order to evaluate progress toward this goal, information is needed on the distribution of tree species and age classes within the urban forest. For public trees, this information can typically be extracted from a good

quality [tree inventory](#). For community trees that are not listed in a tree inventory, this information can most readily be obtained through a [ground survey](#). Accurately determining tree age may not be possible, but for the purposes of evaluation, it will usually suffice to group trees into broad age classes.

#### 4. Promote conservation of tree resources.

The benefits derived from the urban forest generally increase as tree size and canopy cover increase. Therefore, it is in the best interest of the community to protect its existing tree resources from loss or depletion. It is not possible to indefinitely preserve individual trees, since each tree will eventually die. However, it is possible to preserve both the urban forest and natural woodlands by restricting the indiscriminate removal of trees in all age classes, and by making provisions for natural or human-assisted regeneration. This embodies the concept of conservation.

### Ordinance provisions

Many jurisdictions have attempted to address this goal with provisions that require approval to remove certain classes of trees under certain conditions. Unfortunately, in focusing solely on the "preservation" of individual trees, conservation of tree and forest resources is often overlooked. For instance, some ordinances have focused on protection during new construction, but make no provisions to ensure that trees will receive proper care or be retained after construction is completed.

In areas with native tree resources, ordinance provisions that address this goal should conserve stands of trees rather than only individual tree specimens. They should prevent depletion of the tree canopy over both short-term and long-term time horizons. Finally, they should set basic performance standards for the amount of tree canopy to be retained or achieved. Provisions related to the development of a master plan, and those regulating tree planting, protection, and removal are most directly related to this goal.

Conservation of tree resources alone may not be sufficient to address situations that require a more comprehensive resource management perspective. When jurisdictions seek to conserve functional forest and woodland ecosystems, such as in wildland parks or open spaces, the scope of management may need to be expanded. Other components of the plant community, wildlife, natural processes such as fire and flooding, and human land uses may also need to be considered.

Specific provisions:

- [Designate administrative responsibilities](#)
- [Develop a comprehensive management plan](#)
- [Resolution of conflicts between trees and structures](#)
- [Planting requirements](#)
- [Permit required for activities that may damage city owned trees](#)
- [Permit required for activities that may damage protected private trees](#)
- [Conservation of forest and woodland resources during development](#)

### Evaluation methods

If the approach used to attain this goal involves tree protection or "preservation", it will be necessary to have

information on the long-term survival and condition of individual trees. If woodland or forest conservation techniques are applied, the extent, composition, and condition of stands of trees should be documented. Both aerial and ground level [photography](#) provide a simple means for documenting the presence and condition of individual trees and stands of trees over time. [Ground survey](#) methods and [inventory data](#) can also be used to provide more detailed base line data against which change can be measured.

## **5. Select, situate, and maintain street trees appropriately to maximize benefits and minimize hazard, nuisance, hardscape damage, and maintenance costs.**

Trees and structures, such as pavement, sidewalks, and curbs (collectively referred to as hardscape), are closely associated in street tree plantings, and this is frequently a source of problems for both. Many tree maintenance and hardscape damage problems that occur in street tree plantings result from incompatibility between the planting site and the tree species. Street trees are often placed in woefully small planting spaces, resulting in premature tree decline and/or hardscape damage. Conflicts with overhead or underground utilities and damage to hardscape arise where:

- tree species are not selected with proper attention to site limitations,
- planting sites are not designed to provide a hospitable environment for tree growth,
- hardscape, utilities, and structures are not properly engineered to withstand impacts associated with nearby trees.

Inappropriate tree selection is often the underlying cause for trees that become hazardous, are prone to breakage, or develop recurrent pest or disease problems. Inadequate planting sites are often responsible for poor tree growth and survival and excessive hardscape damage. By identifying and subsequently avoiding undesirable tree species, inadequate planting site specifications, and inappropriate tree-site combinations, it is possible to minimize problem situations and their high maintenance costs.

## **Ordinance provisions**

Ordinance provisions related to this goal empower the tree authority to set and modify standards for tree selection and planting sites. This goal is normally also addressed in the development of a comprehensive management plan.

- [Designate administrative responsibilities](#)
- [Develop a comprehensive management plan](#)
- [Responsibilities of property owners](#)
- [Permit required for planting trees in the public right-of-way](#)
- [Planting requirements](#)
- [Permit required for activities that may damage city owned trees](#)

## **Evaluation methods**

To evaluate progress toward this goal, we need information about the types of tree/site combinations that result in high maintenance costs or damage. [Ground surveys](#) can be conducted to determine what types of tree/site combinations are associated with current maintenance and damage problems. Most or all of this

information may already be on hand in cities with [tree inventories](#) that track tree maintenance. Costs of hazardous tree removals, tree-related sidewalk repairs, and maintenance should be tallied by the types of tree species and planting situations where they are incurred. In the absence of good historical records, ground surveys can be conducted to determine what types of tree/site combinations are associated with current maintenance and damage problems. Once these relationships are established, they can be used as a basis to evaluate current tree selection, siting, and maintenance practices. The evaluation should be repeated periodically to account for changes that result as new species, planting methods, and hardscape designs are adopted, and as trees planted at different times mature.

## **6. Centralize tree management under a person with the necessary expertise.**

Due to the wide variety of situations that can impact trees in the urban environment, tree-related issues may arise in a number of different municipal departments. In many jurisdictions, street trees are the responsibility of public works, while park trees are cared for by the parks department (Bernhardt and Swiecki 1989). In addition, projects approved by the planning department and work performed by the public works department often impact current or future tree resources. Utility companies, tree service firms, and private citizens are also involved in tree maintenance and removal, and some of these activities may be regulated by various municipal departments. Effective implementation of tree ordinances is likely to be hampered when responsibilities are split between different departments without overall coordination.

Unless all activities that affect trees are coordinated, departments may unintentionally undermine each other's efforts to conserve tree resources. For example, the planning department may require that certain trees be protected and maintained during development. Without coordination, the same trees might be seriously damaged by trenching for underground utility work approved through public works.

To facilitate the coordinated management of urban forest resources, it is desirable to have a single person responsible for all tree-related issues. To be effective, this position should serve as a clearinghouse for information on activities that may affect trees. The position should also have authority to approve, deny, or condition any activities in accordance with the jurisdiction's management plan, policies, and ordinances. Clearly, the person in this position should have the technical background appropriate for this complex job. Many jurisdictions do have a community arborist or forester, but this position often lacks sufficient authority to effectively manage the urban forest.

Although small communities may lack the funds for a full-time tree specialist, many of the administrative functions of the community forester may be filled by a tree board or commission. The necessary technical input may be obtained from public or private sector tree specialists. Alternatively, several smaller communities might band together to arrange for a shared "circuit riding" urban forester.

## **Ordinance provisions**

Ordinance provisions that establish the responsibilities, authority, and qualifications of the municipal tree program manager relate directly to this goal. Other related provisions direct how coordination between municipal departments is to be established for operations that may affect trees.

- [Designate administrative responsibilities](#)
- [Establish a tree board or commission](#)
- [Specify cooperation between departments and agencies](#)
- [Develop a comprehensive management plan](#)



## Evaluation method

[Municipal records](#) of tree-related permits and maintenance can provide data which show whether this goal is being realized. If tree management is truly centralized, these records should show that all activities that may affect community tree resources have been reviewed and approved by the municipal arborist or forester. [Ground surveys](#), [photogrammetry](#), and [photo points](#) may also be used to document situations in which a lack of coordination has led to unintended or unauthorized tree damage or removal.

## 7. Promote efficient and cost-effective management of the urban forest.

Financial resources are in short supply in many local governments. Even though tree care involves less than 1% of the total operating budget of most U.S. cities ([Bernhardt and Swiecki 1993](#), [Tschantz and Sacamano 1994](#)), economic realities dictate that all municipal programs strive for efficiency and cost-effectiveness.

To operate efficiently and ensure that resources are directed toward the most critical activities, a tree program must have a clear set of priorities and a long-range plan. Although short-term savings may be achieved by deferring tree maintenance, long-term costs will be lowest when resources are spent on preventing problems rather than dealing with them after the fact. For example, a program of early and regular tree maintenance helps prevent later, more costly problems and prolongs tree longevity. Investments in time and money at the time of installation on high quality plant materials and proper site preparation will pay off in terms of tree health and low maintenance costs. Problems arising from poor site designs, defective or diseased planting stock, and improper installation procedures are typically difficult and costly to correct. Similarly, a small investment in the proper pruning of young trees will head off many structural problems that would otherwise develop and require more expensive pruning or tree removal.

## Ordinance provisions

This goal is addressed in provisions that spell out the responsibilities of the tree program manager. These responsibilities should include short- and long-range planning for the tree program, setting maintenance priorities based on long-term benefits, and tracking maintenance costs. Many of these aspects would also be addressed in provisions related to the urban forest management plan.

- [Designate administrative responsibilities](#)
- [Specify cooperation between departments and agencies](#)
- [Develop a comprehensive management plan](#)

## Evaluation methods

[Records](#) on costs and the types of operations performed are used to determine the cost-effectiveness and efficiency of the urban forest management program. An accounting of labor and materials expenses should be maintained, preferably broken down by the types of activities performed, such as tree planting, pruning, and removal. Time devoted to other aspects of the tree management program should also be tracked. Activities such as planning, ordinance enforcement, research, public outreach, and education, are all important to urban forest management. Overhead costs and time should also be tracked and scrutinized, because these costs can have a major influence on the cost efficiency of the entire program.

If work records do not contain sufficient detail to track activities, data can be collected through auditing a representative [sample](#) of work days or other measurement units. Data on the amount of time required to complete various tasks may be self-reported or tracked by an observer.

## **8. Foster community support for the local urban forestry program and encourage good tree management on privately-owned properties.**

To achieve urban forestry goals, the local government needs the support of the citizens in the community. In most jurisdictions, the overwhelming majority of the trees which make up the urban forest are on private property. For all practical purposes, the care of these privately-owned trees is up to the residents of the community. A local government cannot completely control tree management on private lands, but it can take steps to promote proper management of privately-owned trees. Educational and incentive programs are positive ways to encourage good tree care within the community.

It is important that local citizens understand the relationship between urban forestry goals and specific actions taken to achieve these goals. Otherwise, support for the overall program goals may not translate to support for the program itself. Programs to educate citizens about, and involve them in, the local urban forestry program will help increase public support and interest in the program. Voluntary compliance with tree ordinances is likely to be improved if citizens understand and agree with the management approaches implemented through the ordinance.

### **Ordinance provisions**

Provisions that address this goal include those calling for the formation of a citizen tree commission and the establishment of educational and other outreach programs. Conducting such programs may be the responsibility of either the tree program manager or the tree commission. Incentive programs, such as those providing for cost-sharing, grants, or loans for tree planting or maintenance, are also related to this goal.

- [Designate administrative responsibilities](#)
- [Establish a tree board or commission](#)
- [Help for citizens performing tree maintenance](#)

### **Evaluation methods**

There are two distinct aspects to this goal, so evaluating progress requires two different types of methods. The first aspect involves changing the way that people think about the urban forest. [Public opinion polling methods](#) provide the best means to measure changes in public attitudes and knowledge. The process of assessing public attitudes can also serve an educational function in itself, by helping to keep urban forestry issues in the public eye.

Beyond determining what people think, it is also necessary to know if new knowledge or attitudes are translated into action. For instance, if a city decides to use public education to discourage tree removal on private property, it is not enough to know whether public attitudes about this practice have changed. Success is measured by the degree to which changed attitudes result in a decreased incidence of tree removal. This requires the use of techniques that measure the extent of tree resources on private lands over time, including [photogrammetry](#) and [ground survey](#).

## 9. Facilitate the resolution of tree-related conflicts between citizens.

Trees sometimes become the focus of conflict between property owners when they obscure scenic views or keep sunlight from reaching solar energy collectors. Such conflicts may become important where property values are related to specific views (e.g. ocean or lake views). It can be helpful to set up a mechanism by which such conflicts may be resolved with a minimum of impact to the community's tree resources.

### Ordinance provisions

This goal is addressed through a special set of provisions establishing a mechanism for resolving disputes over trees which obstruct light or views. The provisions covering this goal may be included in the tree ordinance or enacted as a separate view or solar access ordinance.

- [Designate administrative responsibilities](#)
- [Procedures to be followed in resolving tree disputes](#)
- [Standards for resolution of tree disputes](#)
- [Apportionment of tree dispute resolution costs](#)
- [Recording for notification of future owners](#)
- [Enforcement of tree dispute resolutions](#)

### Evaluation methods

The effectiveness of the conflict resolution process is the primary issue in evaluating progress toward this goal. The first question to be answered is whether the process is being utilized to resolve tree-related disputes. This information can be easily obtained from [records](#) filed through the system that is established.

Assuming that the process is being used, the next question is whether the process works. This question has to be answered by those who have used the process. Extreme care must be taken to separate reactions to the outcome of the process from reactions to the process itself. It is not reasonable to expect that all parties involved in conflicts will be entirely happy with the eventual resolution. However, if the process is serving its purpose, participants should perceive it as useful and helpful. Carefully-designed [polling procedures](#) and/or follow-up interviews with process participants can be used to rate the effectiveness of the conflict resolution process.

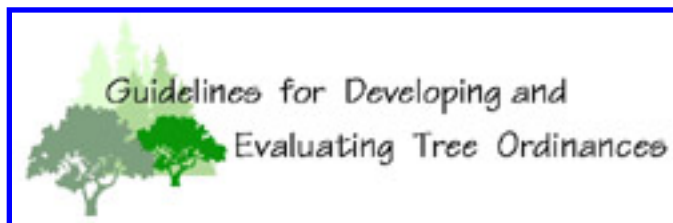

## Part 2. Drafting an ordinance

---

After working through the steps outlined in [Developing a Community Forest Management Strategy](#) , your community may find that a tree ordinance is necessary to further its urban forestry goals. This section is designed to assist you in drafting an ordinance that addresses your specific goals. Tree ordinances are typically made up of provisions that can roughly be separated into two categories, namely **basic provisions** and **provisions for specific goals**. You can produce a draft ordinance by combining the necessary [basic provisions](#) with the appropriate [goal-oriented provisions](#). You may also decide to develop other provisions to address goals unique to your community.

We recommend that simple prose be used in the initial draft ordinance. The draft ordinance should then be submitted to municipal legal staff for review. We have provided an explanation of the purpose of each ordinance provision, a list of its key elements, and notes on its use and implications, and example text from existing ordinances. Many of the existing examples are from the California communities ([Bernhardt and Swiecki 1991](#)), but we will be adding additional examples from throughout the country as this web site is developed further. For a few provisions, we have not yet found good existing examples and have composed example text. We have sometimes omitted (shown by ...) or added (shown by brackets []) code where we deemed it appropriate.

All example provisions are provided for illustration, and are not necessarily "model" provisions. We recommend that you use the examples, key elements, and notes as a starting point for developing language that is suited to meet your local needs. We realize that the 37 provisions described here may not cover every situation. If you are aware of specific provisions that are regionally important or particularly exemplary that you would like to have included here, please contact us using the link below.



## Basic ordinance provisions (Provisions 1-15)

---

Basic Ordinance Provisions are typically found in most ordinances, regardless of their purpose. Most of these are basic structural elements necessary for an ordinance to function. You should review all of these basic provisions to determine which should be incorporated into your tree ordinance. The minimum provisions listed in table below should be included in virtually any tree ordinance. In deciding whether to include other basic provisions, you should consider whether they would be appropriate and useful in your community. Municipal legal staff should also be consulted for an opinion on the legal ramifications of including or omitting any of these basic provisions.

Number	Provision	Minimum
1.	<a href="#">Title</a>	
2.	<a href="#">Findings</a>	
3.	<a href="#">Purpose and intent</a>	yes
4.	<a href="#">Definitions</a>	yes
5.	<a href="#">Determination of definitions</a>	
6.	<a href="#">Jurisdiction</a>	
7.	<a href="#">Policies regarding trees</a>	
8.	<a href="#">Local government disclaims liability</a>	
9.	<a href="#">Interference with planting, maintenance, and removal unlawful</a>	
10.	<a href="#">Appeals</a>	yes
11.	<a href="#">Penalty for violation</a>	yes
12.	<a href="#">Enforcement</a>	yes
13.	<a href="#">Performance evaluation of ordinance</a>	yes
14.	<a href="#">Severability</a>	yes
15.	<a href="#">Designate administrative responsibilities</a>	yes

---

## 1. Title

**Purpose:** To give the ordinance a brief descriptive title.

*This ordinance shall be known as the San Francisco Urban Forestry Ordinance.  
[San Francisco, CA: Public Works Code Article 16 Section 800]*

## 2. Findings

**Purpose:** To set forth the reasons the local government finds it necessary to adopt an ordinance.

**Notes:** This section is frequently used to present a list of benefits provided by trees and justify the local government's interest in protecting the tree resource. Findings from the evaluation of "[what you have](#)" might also be included in this section.

*Information obtained from a City survey of trees indicated a decline in the  
number of certain species of trees located on private property.  
[Carmel-by-the-Sea, CA: Ordinance No. 89-18]*

## 3. Purpose and intent

**Purpose:** To set forth the goals to be achieved through the ordinance.

**Notes:** In this section, you should clearly state the goals you hope to achieve by enacting the ordinance. It is useful to establish goals which are quantifiable in some way. However, this approach has not been taken in most existing ordinances. The example text is derived from the goals discussed in [Part 1](#).

*This ordinance establishes policies, regulations, and standards necessary to ensure that the city will continue to realize the benefits provided by its urban forest. The provisions of this ordinance are enacted to:*

- A. Establish and maintain the maximum sustainable amount of tree cover on public and private lands in the city;*
- B. Maintain city trees in a healthy and nonhazardous condition through good arboricultural practices;*
- C. Establish and maintain appropriate diversity in tree species and age classes to provide a stable and sustainable urban forest.*

[Example code by the authors]

## 4. Definitions

**Purpose:** To define key words which are to be used in the ordinance.

**Notes:** It should become clear which terms require a definition as the ordinance is drafted. Communities have found it necessary to define what they mean by such words as "tree", "street tree", "prune", "Director", "damage", "parkway" and many others. Sometimes a useful technique, illustrated in the example text, is to include in the definition what is not covered by the term.

*For the purposes of this chapter, the following words and phrases shall have the meanings respectively ascribed to them by this section: "Alter" means to take action by cutting or pruning any tree, or by filling, surfacing, grading, compacting or changing the drainage pattern of the soil around any tree in a manner that threatens to diminish the vigor of the tree; provided that, as used in this chapter, the term "alter" does not include: 1. Normal seasonal trimming, shaping, thinning or pruning of a tree necessary to its health and growth;...*

[Fairfax, CA: Town Code Section 8.28.020]

## 5. Determination of definitions

**Purpose:** To establish an authority responsible for interpreting definitions.

**Notes:** The application of many provisions may hinge on the definitions of key terms. This provision reduces the chance that ordinance enforcement could be challenged on the basis of specific definitions.

*In any case, the city forester shall have the right to determine whether any specific woody plant shall be considered a tree or a shrub. Such determination shall be final and not subject to appeal.*

[Carmel-By-The-Sea, CA: City Code Section 12.28.040]

## 6. Jurisdiction

**Purpose:** To set forth the jurisdiction of the local government over certain groups or classes of trees.

**Notes:** The example is typical of street tree ordinances. Some cities claim jurisdiction over trees on private property under certain situations as well.

*The City of Carpinteria shall have control of all street trees, shrubs, and other plantings now or hereafter in any street, park, public right-of-way or easement, or other public place within the City limits, and shall have the power to plant, care for, maintain, remove, and replace such trees, shrubs and other plantings.*

[Carpinteria, CA: City Code Section 12.28.020]

## 7. Policies regarding trees

**Purpose:** To set guidelines for carrying out ordinance provisions.

**Notes:** Whereas a goal is a statement of what you hope to achieve, a policy sets forth guiding principles to be followed in trying to achieve the goals. Stated policies may be helpful in interpreting and implementing ordinance provisions.

*It shall be the policy of the City to maximize the planting of trees alongside the streets of the city...*

[Alhambra, CA: City Code Section 14.08.004B]

*C. It is the policy of the city to line its streets with trees and to conduct a consistent and adequate program for maintaining and preserving these trees...*

*D. It is the policy of the city to encourage new tree planting on public and private property and to cultivate a flourishing urban forest.*

[San Luis Obispo, CA: City Code Section 12.24.010]

*Street tree plantings shall first be considered from the standpoint of the people using or passing along the streets and in terms of the broader community benefit. Of secondary consideration is the benefit, embellishment, or enhancement of the properties abutting the street.*

[Carpinteria, CA: City Code Section 12.28.070]

## 8. Local government disclaims liability

**Purpose:** To avoid accepting liability for any personal injury or property damage caused by trees on private property.



**Notes:** Legal counsel should be consulted for an expert opinion on the drafting and validity of such clauses. A provision of this nature is usually included if a local government claims the authority to abate hazardous trees or regulate tree pruning and removal on private property. The first example is typical of a provision used in a street tree ordinance.

*Nothing contained in this section shall be deemed to impose any liability upon the city, its officers or employees, nor to relieve the owner of any private property from the duty to keep any tree, shrub or plant upon any street tree area on his property or under his control in such condition as to prevent it from constituting a hazard or an impediment to travel or vision upon any street, park, pleasure ground, boulevard, alley or public place within the city.*

[Patterson, CA: City Code Section 12.13.160]

The second example is found in an ordinance that regulates the removal of protected trees (native oaks) on private property.

*Nothing in this ordinance or within the Oak Tree Preservation and Protection Guidelines shall be deemed to impose any liability for damages or a duty of care and maintenance upon the City or upon any of its officers or employees. The person in possession of public property or the owner of any private property shall have a duty to keep the oak trees upon the property and under their control in a safe, healthy condition. Except as provided in Section 5-14.04(b), any person who feels a tree located on property possessed, owned or controlled by them is a danger to the safety of themselves, others or structural improvements on-site or off-site shall have an obligation to secure the area around the tree or support the tree, as appropriate to safeguard both persons and improvements from harm.*

[Thousand Oaks, CA: City Code Section 5-14.07]

## 9. Interference with planting, maintenance, and removal unlawful

**Purpose:** To prohibit interference with persons involved in tree-related activities who are acting in their official capacity on behalf of the local government.

**Notes:** This provision may be unnecessary if other portions of code restrict interference with public employees acting in their official capacities.

*No person, firm or corporation shall interfere with the director of public works or persons acting under his authority while engaged in planting, mulching, pruning, ..., or removing any tree, shrub or plant in any street, ..., or public place within the city ...*

[Bakersfield, CA: City Code Section 12.40.070]

## 10. Appeals

**Purpose:** To establish a procedure whereby decisions of the tree program manager can be appealed.

**Key elements:**

- Types of decisions subject to appeal
- Procedure for filing appeals
- Time limitations for appeals and responses to appeals
- Requirement to suspend actions during the appeal process
- Hierarchical sequence of appeals
- Rules governing the hearing process, unless provided for elsewhere

**Notes:** The appeal process provides a check against the authority of the tree program manager. However, it is important that decisions by appeal bodies be based on the ordinance and established policies rather than political pressure.

*Any action of the director of recreation and parks may be appealed to and heard by the recreation and parks commission. To be effective, an appeal must be filed within ten (10) days after the decision of the director. The appeal shall be in writing and shall be filed with the director for placement on the commission's agenda. The appeal shall clearly specify the reasons for which a hearing is requested. After a hearing, the recreation and parks commission shall render its decision, which shall be final unless appealed to the city council. To be effective, an appeal to the city council must be in writing, state the reasons for the appeal, and must be filed with the city clerk within ten (10) days after notice of the decision of the recreation and parks commission is mailed to the applicant. The decision of the city council shall be final.*

[Santa Maria, CA: City Code Section 27-13]

*...Such hearing on appeal shall be de novo, and the appeals board shall be guided by the criteria and standards, and shall make findings in relation thereto, as are required for the issuance of a permit in the first instance...*

[Paradise, CA: Municipal Code Section 8.12.110B]

*...Action under any permit, the issuance of which has been appealed, shall be suspended pending final decision of the city council on the appeal...*

[Newark, CA: City Code Section 8.16.060]

## 11. Penalty for violation

**Purpose:** To establish penalties for violating provisions of the ordinance.

**Key elements:**

- Legal categorization of violations
- Specific penalties, if not provided for elsewhere
- Legal means for stopping and correcting situations which constitute violations

**Notes:** Depending on the nature and complexity of the tree ordinance, penalties for violations may be listed in a single provision or in several different parts of the ordinance, and the penalties may be simple or complex. A simple tree ordinance may address one issue (e.g., protection of trees in the public right of way),

so one simple penalty provision may suffice.

*(a) Violation of any section of this chapter shall be a basis for injunctive relief.*

*(b) Violation of any section of this chapter shall be an infraction.*

[Santa Maria, CA: City Code Section 27-15]

*Any person, partnership, firm, corporation, or other legal entity who violates any provision of this chapter is guilty of a misdemeanor punishable by a fine of not more than one thousand dollars, or by imprisonment in the county jail for a period not exceeding six months, or both such fine and imprisonment. All such violations which are of a continuing nature shall constitute a separate offense for each day of such continuance. Any violation of this chapter shall also constitute a public nuisance and may be enjoined and abated as provided by law.*

[Corte Madera, CA: City Code Section 15.50.080]

A more comprehensive tree ordinance may address a wide variety of issues, including the care of public trees, protection of designated trees or forest resources on private property, and planting requirements for new developments. Different types of penalties may therefore be appropriate for violations of different sections of the ordinance. In such cases, the penalty provision may either list all of the penalties that may apply to violations of various provisions, or may state the basic penalties and indicate that additional penalties may be listed under specific provisions.

The following penalty provision example from a tree protection ordinance includes references to replacement standards listed elsewhere in the ordinance.

*PENALTIES: Any Person who neglects or refuses to comply with, or assists in the violation of, any of the provisions of this Chapter, or any order, permit, or notice issued pursuant thereto, shall be fined not more than \$500 for each such violation and shall pay in addition the cost of replacement as provided in this Section. Each day any such violation continues shall constitute a separate offense, and each Tree Removed or Damaged shall also constitute a separate offense. Any Person who causes a Tree to be Removed or Damaged in violation of this Chapter, or any order, permit, or notice issued pursuant thereto, shall repair or replace any such Tree at the violator's sole cost and expense pursuant to the Tree replacement requirements set forth in Subsection 10-11-4E of this Chapter. The cost of replacement shall be \$100 for each DBH inch of the Removed or Damaged Tree. If the precise DBH cannot be determined, the cost of replacement shall be determined by the Village Forester based on the Village Forester's estimate of the DBH of the Removed or Damaged Tree. The replacement cost shall be paid to the Village by the Person responsible for the violation. The location, species, and planting specification for replacement Trees shall be approved prior to replanting by the Village Forester pursuant to the requirements of Subsection 10-11-4E of this Chapter.*

[Lake Bluff, IL: Village Code Section 10-11-16]

In general, penalties need to be sufficient to provide deterrent value. Minor fines or inconsequential penalties

may simply be accepted as the "cost of doing business" and may not provide any real deterrent value. The withholding of permit approvals needed to complete construction or conduct business may provide meaningful deterrent value until a project is completed, but have little deterrent value if violations are discovered after project completion. The following example includes the possibility of revoking approvals or permits. If this remedy was used, it would potentially provide a means for extending the deterrent value of the penalties beyond the date of project completion.

*Withholding or revocation of city permits. Failure of any party to follow the procedures as required by this section shall constitute grounds for withholding or revoking site plan approval, building permits, occupancy permits or any other appropriate approvals necessary to continue development. Such extraordinary sanctions, however, shall be instituted immediately upon the direction of the city manager and with the ratification of the city commission at its next regular or special meeting. This ratification shall be considered a public hearing at which all interested parties shall have notice and an opportunity to be heard and to be represented by legal counsel.*

[Coral Springs, FL: City Code Section 212.N.2]

The following example provides an alternative approach to withholding permit approvals beyond the time that a project is completed. This approach would be of value only for developers or landowners that are likely to initiate other projects within the city.

*The owner or occupant of any property on which a violation of the provisions of this Chapter was committed, if such violation was committed by the owner or a lawful occupant thereof, or committed with the permission or approval of either such person, shall be denied, for a period of two years from the date of the City's discovery of such violation, any approval or permit issued by the City for the development or further improvement of such property. Prohibited approvals or permits shall include, but not be limited to, conditional use permits, variances, and building or demolition permits. The provisions of this Chapter shall not apply to any approval or permit which is needed or required to maintain the health or safety of those occupying existing improvements on the property.*

[Santa Rosa, CA: draft ordinance]

In Maryland, operating a tree care businesses without a state license is designated as a "must appear" offense, i.e., the perpetrator must appear in court and cannot simply send in the fine. This additional burden presumably increases the deterrent value of the penalty. The following example lists a set of specific remedies required for violation of provisions prohibiting "tree abuse", which includes topping and a number of other destructive practices (see [provision 23](#)). The required remedies generally seek to undo or mitigate the damage caused by the violation, rather than simply penalizing the violator. It also sets a time limit for the completion of remedial actions.

*Remedial actions required.*

*(1) In the event a person abuses a tree in violation of this section, the violator, in addition to being subject to the penalties found in section 1-15 of the City Code, shall be responsible to undertake pruning and other remedial actions that the city determines are reasonably necessary to protect public safety and property, and to help the tree survive the tree abuse damage.*

*(2) If the natural habit of growth of the tree is destroyed, the violator shall remove the abused tree and install a replacement tree.*

*(3) Tree replacement criteria shall be consistent with that established in section 16-172(f).*

*(4) Replacement trees shall be installed on-site. In the event the site cannot accommodate all required replacement trees, the remaining replacement trees shall be installed on public lands if approved by the city. If no suitable public lands are located, the violator shall pay a replacement contribution into the reforestation account. The replacement contribution will be determined using a schedule for current value of replacement trees plus installation and maintenance as established by the city.*

*(5) Remedial actions and replacement required under this section shall be completed within sixty (60) days of notice from the city that such actions are required. The city may require the violator to immediately undertake remedial actions in the event the abused tree is an immediate threat to the public or property.*

[Sunrise, FL: City Code Section 16-173c]

The responsibility for enforcement of the ordinance should be designated as described in provisions 12 ([Enforcement](#)) and/or 15 ([Designate administrative responsibilities](#)).

## 12. Enforcement

**Purpose:** To designate the position responsible for enforcing the ordinance.

**Notes:** The authority designated to enforce the ordinance should always be indicated. However, a separate enforcement provision may not be necessary if the responsibility for ordinance enforcement is specified under provision 15 ([Designate administrative responsibilities](#)). It is normally preferable to vest enforcement authority with the tree program manager.

*The Public Works Administrator is hereby charged with the responsibility for the enforcement of this ordinance and may serve notice to any person in violation thereof or institute legal proceedings as may be required, and the City Attorney is hereby authorized to institute appropriate proceedings to that end.*

[Lemoore, CA: Ordinance 8610 Section 10-1.12]

## 13. Performance evaluation of ordinance

**Purpose:** To provide for evaluation of the success of ordinance provisions.

**Key elements:**

- Position responsible for evaluation and reporting (unless specified in provision 15-[Designate administrative responsibilities](#))
- Actions required in case of unsatisfactory performance

**Notes:** Perfection is seldom achieved on the first attempt. As noted in Part 1, the management planning process is incomplete without review, evaluation, and revision. One way to ensure that evaluation does occur is by including a provision that mandates a periodic performance evaluation of the ordinance. In addition to evaluation, this provision should establish a mechanism for revision of the ordinance if goals are not being achieved.

When we wrote the original *Guidelines* in 1991, we provided the following example because we could not find examples of this type of provision in use:

*The tree program manager shall collect and maintain all records and data necessary to objectively evaluate whether progress is being made toward the stated goals of this ordinance. An annual summary and analysis of the evaluation, and recommendations for action shall be prepared at the direction of the tree program manager and presented to the City Council. The City Council shall consider the report and recommendations and take all actions deemed necessary to accomplish the goals of this ordinance. These actions may include, but are not limited to, revision or amendment of this ordinance or the adoption of other resolutions or ordinances.*

[Example code by the authors]

The following code shows how the above example was adapted by one community in their tree ordinance:

*The director or his/her designee shall collect and maintain all records and data necessary to objectively evaluate whether progress is being made toward the intent, purpose and objectives of this chapter. The director shall prepare an annual report. The park board shall consider the report recommendations and take all necessary action to accomplish the goals and objectives of this chapter.*

[Everett, WA: Municipal code 8.40.050 (Ord. 1948-93 § 5, 1993) ]

Complex tree management issues, such as those dealing with the conservation of existing tree and forest resources (see provision [31](#) and [32](#)), clearly require close monitoring. The outcome of tree and woodland conservation provisions must be monitored on an ongoing basis to determine whether the strategies used have been successful. In addition, monitoring data is needed to show how the resource changes over time and whether new issues have arisen since the original implementation of the ordinance. The following example code is part of the Maryland Forest Conservation Act, which is discussed in detail under [provision](#)

32.

**Annual report.** *On or before July 1 of each year, the Department shall submit... a statewide report, compiled from local authorities' reports to the Department, on:*

*(1) The number, location, and type of projects subject to the provisions of this subtitle;*

*(2) The amount and location of acres cleared, conserved, and planted, including any areas which utilize forest mitigation bank credits, in connection with a development project;*

*(3) The amount of reforestation and afforestation fees and noncompliance penalties collected and expended;*

*(4) The costs of implementing the forest conservation program; and*

*(5) The size, location, and protection of any local forest mitigation banks which are created under a local or State program.*

[Annotated Code of Maryland Sec 5-1613]

## 14. Severability

**Purpose:** To prevent the whole ordinance from becoming invalid if any part of it is declared invalid by the courts.

**Notes:** This provision is included in many ordinances as a matter of course. It is probably unnecessary to include in very short ordinances.

*Should any part or provision of this ordinance be declared by a court of competent jurisdiction to be invalid, the same shall not affect the validity of the ordinance as a whole or any part thereof other than the part held to be invalid.*

[Atherton, CA: Ordinance 444 Section 7]

## 15. Designate administrative responsibilities

**Purpose:** To assign responsibility and authority for implementation and enforcement of the ordinance.

**Key elements:**

- Position(s) responsible for implementing provisions of the ordinance
- Responsibilities assigned to each position
- Confirmation of authority necessary to carry out specified duties

**Notes:** A provision to designate responsibility for ordinance implementation is a basic requirement of any tree ordinance. This provision can also be used to help accomplish any of the specific urban forestry management goals, since it assigns the responsibility and authority for management activities.

Although it is preferable to centralize tree management under the tree program manager, other municipal departments or a citizen tree advisory board may have complementary responsibilities. Listing the responsibilities of all parties involved in the tree management program in one section makes it easier to avoid conflicting or overlapping responsibilities.

**Tree program manager.** As the lead position for the management of municipal tree resources, the tree program manager should be vested with the authority necessary to carry out his or her many responsibilities. The actual list of responsibilities will vary with each community, but may include:

- developing and updating the comprehensive management plan;
- implementing a monitoring program to evaluate whether goals are being met;
- directing municipal tree care operations, including planting, maintenance, and removal;
- preparing the municipal tree care budget;
- seeking funding from state, federal, or other granting agencies;
- evaluating and approving permits for activities that may affect trees;
- conducting community outreach and education programs;
- enforcing ordinance provisions.

The tree program manager should have the expertise necessary to carry out the many complex duties of the position. Minimum qualifications for this position can also be specified in this section.

In the first example, the Director of Public Works serves as the community forester. In this example, responsibility may exceed authority to some degree.



*The director of public works shall, by use of city employees or private contractors, plant, maintain and otherwise care for, or if necessary remove trees in any public place in the city. The responsibilities of the director of public works shall include but not be limited to, the following:*

- 1. Prepare an annual program for tree planting and tree care in public places of the City;*
- 2. Recommend to the board of directors changes or additions to the Master Street Tree Plan;*
- 3. Develop maintenance standards as they relate to street trees in public places;*
- 4. Inspect the planting, maintenance and removal of all trees in public places;*
- 5. Make determination of tree removals in public places;*
- 6. Review all landscaping plans as they affect trees in public places; and*
- 7. Act as advisor to the Design Committee of the City.*

[Pasadena, CA: Ordinance 5454 Chapter 8.52.030]

A more specific link between responsibility and authority is seen in the second example.

*The Director of Planning and Community Development, under the general supervision of the City Manager, shall have the authority and responsibility to do the following:*

- 1. Administer and enforce the provisions of this Chapter...*

[Ceres, CA: Municipal Code Section 12.16.100]

In the third example, responsibilities for monitoring and reporting on the tree program are clearly stated.

*The Park Superintendent shall prepare and maintain all necessary maps, plans, and records relating to the various functions carried on under this chapter.*

*The Park Superintendent shall report to the Council annually on the work and activities carried on under the provisions of this Chapter...*

[San Buenaventura, CA: City Code Section 8413]

The example provision below expressly gives the tree program manager the authority to promulgate the additional rules and regulations necessary to implement the tree ordinance. This provides flexibility and helps avoid burdening the tree ordinance with excessive amounts of technical detail.

*In conjunction with the director of planning and community development and public works, the parks director is authorized to promulgate rules, regulations and policies including the public tree policy to administer and implement the provisions of this chapter.*

[Everett, WA: City code 8.40.080 (Ord. 1948-93 § 8, 1993)]

We have tried to emphasize throughout this site that a well-informed and supportive populace is of critical importance to the community forestry program. The responsibility for conducting a public education program may be assigned either to the tree program manager or the tree commission. In either case, the provision

should state the overall goals of the education/outreach program, as in this example.

*Public Education. The Division shall undertake an ongoing program of public outreach and education in order to promote public understanding of the City's urban forest and public adherence to the standards and procedures established under this ordinance.*

[San Francisco, CA: Public Works Code Section 804h]

**Tree advisory board.** In many communities, the tree advisory board or commission is instrumental in evaluating needs, setting goals, and establishing policy for the community forestry program. The tree advisory board may also hear appeals of decisions made by the tree program manager.

*The urban forestry tree committee:*

*A. develops, renews, and updates the vegetation management plan and the arboricultural manual and submits them to the park board and city council for approval and adoption;*

*B. reviews City plans and policies which contain matters relating to urban forestry, community values, arboriculture, and horticulture;*

*C. recommends legislation regarding the urban forest;*

*D. adopts rules of operation and schedule of meetings;*

*E. provides the park board with an analysis of the annual urban forestry budget request;*

*F. develops a program for identifying and maintaining trees in the city which have significant historical, cultural, environmental or public significance and makes recommendations to the park board and city council on adopting such a program;*

*G. coordinates the City's Arbor Day programs, grants, and other similar programs;*

*H. provides information regarding the selection, planting and maintenance of trees on public and private property.*

[Spokane, WA: City Code Section 4.28.050]

In small communities, the tree advisory board may act in lieu of a tree program manager, performing many of the administrative functions listed above. However, as an appointed body, the tree board is not normally in a position to enforce the tree ordinance on a day-to-day basis. In such situations, enforcement responsibility should be assigned to a municipal staff position (see provision 12, [Enforcement](#)).

*The duties of the Tree Committee shall be as follows:*

- 1. To study the problems and determine the needs of the City in connection with its tree program.*
- 2. To recommend to the City Council the type and kind of trees to be planted upon such City streets or parts of City streets, parks, or public places.*
- 3. To assist the properly constituted officials of the City, as well as the Council and citizens of the City, in the dissemination of news and information regarding the protection, maintenance, removal, and planting of trees on public lands, and to make such recommendations from time to time to the City Council as to desirable legislation concerning the tree program and activities for the City.*

[La Palma, CA: City Ordinance No. 89-07 Section 4B]



## Ordinance provisions for specific goals (Provisions 16-25)

---

Provisions from this category should be selected on the basis of whether they are appropriate to your community and consistent with your management goals. It is neither necessary nor desirable that every community adopt each of these provisions. In assembling your ordinance, you should consider those provisions that correspond to the specific goals you have established. The goal-oriented provisions are numbered 15 through 37 in the table below. Each of these provisions is related to one or more the nine management goals discussed under [Goals for Community Forest Programs](#) and can be accessed from the links on that page. Many of these management goals are interrelated, so some provisions are referenced to several different goals. Many of the [basic provisions](#) (e.g., Provision 15, [Designate administrative responsibilities](#)) are directly related to many of the listed goals and should be included in most ordinances.

<b>Number</b>	<b>Provision</b>	<b>Goals</b>
16	<a href="#">Establish a tree board or commission</a>	6,8
17	<a href="#">Specify cooperation between departments and agencies</a>	6,7
18	<a href="#">Develop a comprehensive management plan</a>	1,2,3,4,5,7
19	<a href="#">Resolution of conflicts between trees and structures</a>	1,2,4
20	<a href="#">Exemption from Solar Shade Control Act (California)</a>	1
21	<a href="#">Responsibilities of property owners</a>	5
22	<a href="#">Help for citizens performing tree maintenance</a>	2,8
23	<a href="#">Topping prohibited</a>	2
24	<a href="#">Permit required for planting trees in the public right-of-way</a>	5
25	<a href="#">Planting requirements</a>	1,2,3,4,5
26	<a href="#">Situations which are declared to be public nuisances</a>	2
27	<a href="#">Abatement of hazards and public nuisances</a>	2
28	<a href="#">Licensing of private tree care firms</a>	2
29	<a href="#">Harming public trees forbidden</a>	2
30	<a href="#">Permit required for activities that may damage city owned trees</a>	1,2,4,5
31	<a href="#">Permit required for activities that may damage protected private trees</a>	1,2,4
32	<a href="#">Conservation of forest and woodland resources during development</a>	1,3,4
33	<a href="#">Procedures to be followed in resolving tree disputes</a>	9

34	<a href="#">Standards for resolution of tree disputes</a>	9
35	<a href="#">Apportionment of tree dispute resolution costs</a>	9
36	<a href="#">Recording for notification of future owners</a>	9
37	<a href="#">Enforcement of tree dispute resolutions</a>	9

## 16. Establish a tree board or commission

**Purpose:** To establish a citizen advisory board, commission, or committee.

**Key elements:**

- Composition of the board
- Rules which govern the board
- Responsibilities and authority (if not defined in provision 15 - [Designate administrative responsibilities](#))

**Notes:** Tree boards provide a means to involve the public in urban forestry management. Tree boards can promote new and existing tree programs by motivating both local government and the public to support urban forest management. Typical functions of the tree board are described in provision 15 ([Designate administrative responsibilities](#)), and will vary with the community. Sometimes city staff members are included on the tree board.

*There is hereby created a City Tree Advisory Board which shall consist of five members....The members shall be lay citizens and others with established professional competence in a pertinent discipline, and the following characteristics or attributes may serve as guidelines in making appointments to the Board:*

- 1. Members of the public interested in trees as a major component of Carpinteria's physical and aesthetic environment.*
- 2. Arborists, ornamental horticulturists, and landscape architects and designers, or those with a technical background in a related field. At least two members of the Board shall have such a professional background....*

[Carpinteria, CA: City Code Section 12.28.080]

*There shall be a beautification or tree commission in the city consisting of 7 members, appointed by the mayor, subject to approval of the city council. Their terms of office shall be 3 years and until their successors are appointed and qualified... The members shall serve without compensation, but all necessary expenses shall be paid by appropriate council action.*

*The city council may remove any appointed member of said commission from office prior to the expiration of their term, with or without cause by an affirmative vote of not less than three-fifths of the members of the city council.*

*Vacancies on the commission, ... , shall be filled by appointment by the mayor, subject to approval of the city council.*

*The commission shall hold regular meetings at least once each month, and may hold such addition meetings as it deems necessary. A majority of the commission shall constitute a quorum for the purpose of transacting the business of the commission. The commission shall, as soon as practical after the time of the annual appointment of a member to the commission, elect a chairman, vice-chairman, and a secretary thereof..*

*The secretary of the commission shall keep a record of all proceedings, resolutions, findings, determinations and transactions of the commission, which records shall be a public record, and a copy of which record shall be filed with the city clerk as clerk of the city council..*

[Burlingame, CA: City Code Chapter 3.28]

## **17. Specify cooperation between departments and agencies**

**Purpose:** To require cooperation between municipal departments in matters pertaining to tree resources.

**Key elements:**

- List of activities that require consultation between departments
- Responsibilities of municipal departments to coordinate activities

**Notes:** Urban trees are subjected to wide variety of potentially damaging impacts from municipal departments, utility companies, and private contractors. Maintenance of above- and below-ground utilities and other infrastructure may lead to serious tree damage or tree death. Adverse impacts can often be minimized or avoided but only if the the input of tree professionals is obtained before damage is inflicted. The urban forester or tree program manager should be given the responsibility and authority to require modifications to various activities that may adversely impact city trees (see provision 15 - [Designate administrative responsibilities](#)). Even if the tree program manager has this authority, it may be helpful to include this additional provision to explicitly require that departments, agencies, utilities, and others communicate and cooperate with the community forest program when they conduct operations that can affect trees.

*A. The Public Works Department shall notify the Parks and Recreation Department of any applications for new curb, gutter, sidewalks or driveway installations, or other improvements which might require the removal of or cause injury to any street tree, or interfere with the fulfillment of the street tree plan.*

*B. Any public utility maintaining any overhead wires or underground pipes or conduits shall obtain permission from the Director before performing any maintenance work on the wires, pipes, or conduits which would cause injury to street trees. The public utility shall in no way injure, deface, prune, or scar any street tree until their plans and procedures have been approved by the Director...*

[Modesto, CA: City Code Section 12-5.08]

*In order to provide for coordination and the maximum feasible use of all public lands, areas and funds, plans and specifications for city street and public area planting proposed by the landscape supervisor shall be submitted to the city engineer, traffic engineer, planning director, and where appropriate, special district directors and managers, for their recommendations, and such recommendations shall be made within thirty days after receipt of such plans and specifications. To facilitate the planting and maintenance of trees in new subdivisions, developments, streets and public areas, the planning director shall advise and cooperate with the landscape supervisor in carrying out the provisions of this chapter.*

[Camarillo, CA: City Code 13.12.080]

## **18. Develop a comprehensive management plan**

**Purpose:** To develop an integrated management plan for the urban forest.

### **Key elements:**

- Responsibility for developing and updating the comprehensive management plan (if not defined in provision 15 -[Designate administrative responsibilities](#))
- Method by which the plan is to be adopted and revised
- List of elements to be included in the plan

**Notes:** The comprehensive tree management plan is the keystone of any tree program, because it lays out the framework for tree management in the community. Much of the work needed to develop the comprehensive plan will already be completed if you have followed the process discussed under [Developing a Community Forest Management Strategy](#). Throughout the entire management planning process, public input and public education should be given high priority. Authority for developing and implementing the plan should be assigned.

Some elements to be considered in the management plan include:

- inventory of existing trees;
- identification of planting sites;

- prioritized planting plan;
- standards for tree selection, siting, planting, and pruning;
- scheduled maintenance for new and established trees;
- inspection program for tree-related problems and hazards;
- guidelines for protecting existing trees from construction-related damage;
- integrated disease and pest management strategies;
- reforestation plans that allow for phased removal and replacement as trees become a liability;
- plans for utilization of waste wood.

*Within three years of the adoption of this Ordinance, the Director with the advice and participation of the Tree Board shall adopt an Urban Forest Management Plan. The Division thereafter shall use its best efforts to insure that activities of the Division are guided by such plan. The plan shall incorporate the following elements:*

*(a) A clear, concise, and comprehensive Statement of Policies and Objectives for urban forestry management in the City, which statement is to be developed by the Director with the advice and participation of the Tree Board through a process of at least three public hearings;*

*(b) A designation of proposed urban forestry treatments for major traffic routes and districts within the City consistent with the City's Master Plan, together with a program, schedule, and suggested budget for implementing such treatments;*

*(c) An inventory of every street tree and any other trees deemed necessary by the Division, which inventory shall include, as appropriate, species, age, condition, maintenance records, names of adjacent property owners, record of fees and fines, and any other information necessary or usable in the long-range planning or day-to-day planting and maintenance of the City's urban forest;*

*(d) A Street-Tree Renewal Plan, based on an evaluation of species characteristics and performance as recorded in the inventory, providing for rotational reforestation of diseased or declining trees and break-up of potentially problematic monocultures;*

*(e) A set of Standards for the Division, and the public for street-tree installation, landscape-tree installation, pruning and maintenance, acceptable tree species and any other standards, criteria, or administrative procedures deemed necessary to carry out the purposes of this Ordinance and the Urban Forest Management Plan;*

*(f) A process for continual update and improvement of the Urban Forest Management Plan elements.*

[San Francisco, CA: Public Works Code Section 806]

*Management program. In consultation with the parks commission, planning*



*commission and public works department, the director of parks and recreation or his/her designee, shall develop and implement a public tree policy consistent with other city regulations designed to provide an orderly program of tree management. Such program shall include all public property and rights-of-way including parks, public greenbelts and other city-owned property except Lake Chaplain. The development of such a program include the following objectives:*

- A. The setting of standards for the planting, maintenance, protection, preservation, removal and replacement of existing trees;*
- B. Planning and planting of trees for future benefit of the citizens of Everett;*
- C. Approval of all tree plantings, maintenance, and removal of trees on city-owned property and rights-of-way; and*
- D. In the short term, no net loss of forest canopy cover on city-owned public lands and right-of-way; in the long term, measurable gain.*

[Everett, WA: City Code Section 8.40.040]

## **19. Resolution of conflicts between trees and structures**

**Purpose:** To set priorities for solving conflicts between trees and street improvements.

**Key elements:**

- Priority of trees over street improvements (hardscape)
- Responsibility for approving corrective measures

**Notes:** Tree-related damage to street improvements is common in many communities. Although tree roots are blamed for the cracking concrete and invading sewer lines, it is equally valid to point out that these structures fail because they have not been properly engineered to function in a landscape that contains growing trees and their roots. Unfortunately, the approach in too many cities has been to remove trees rather than to find a way to redesign structures to be compatible with trees. This provision can be used to establish the priority of trees over hardscape. Individual property owners normally do not have the resources or expertise to develop satisfactory solutions to tree- hardscape conflicts on their own. Therefore, the responsibility for correcting conflicts between trees and street improvements should not be assigned to the property owner. However, if the conflict results from actions by a property owner which violate municipal tree planting standards, the city may require the property owner to bear some or all of the cost of corrective action.

*A. When roots of a tree planted within the planting area damage city curbs, gutters and sidewalks (including driveway ramps), the city shall be responsible for appropriate corrective measures which are least damaging to the tree.*

[San Luis Obispo, CA: City Code Section 12.24.150]

*Where sidewalk or curb damage due to tree roots occurs, every effort shall be made to correct the problem without removing or damaging the tree. The city forester shall be responsible for developing or approving corrective measures in consultation with the city engineer.*

[Example code by the authors]

## **20. Exemption from Solar Shade Control Act (California)**

**Purpose:** To exempt a local jurisdiction from the provisions of the California Solar Shade Control Act.

**Notes:** The Solar Shade Control Act of 1979 (California Public Resources Code Section 25980 et seq.) prohibits shading of solar collectors that results from tree growth occurring after a solar collector is installed. One problem with this law is that trees which are in place before a solar collector is installed may come to be in violation through further growth. Cities and counties may, by majority vote of the governing body, exempt themselves from the provisions of the act.

*The city is exempt from the provisions of Chapter 12 (commencing with Public Resources Code section 25980), Division 15 of the Public Resources Code which chapter is known as the Solar Shade Control Act.*

*[Carmel-By-The-Sea, CA: City Code 12.28.050]*

## **21. Responsibilities of property owners**

**Purpose:** To set forth any responsibilities for maintenance of trees, either public or private, assigned to property owners.

### **Key elements:**

- Designation of responsible parties
- Assignment of responsibilities
- Performance standards for maintenance activities

**Notes:** In many communities, residents are responsible for some types of tree maintenance, particularly for trees which extend over public rights-of-way. In such cases, it is the responsibility of the municipal tree program to provide information on the types of care to be provided and complete instructions on proper methods. For example, if residents are responsible for tree trimming to maintain clearance for pedestrian and vehicular traffic, standards for clearances and information on proper pruning methods should be readily available to residents. Even if standards are set and distributed, the municipality may still have little control over the quality of maintenance performed by residents. As an alternative, the municipality may simply require residents to notify the tree program when problems occur, and have work done by municipal crews or contractors. This allows for greater control over the quality of tree maintenance.

*(a) It shall be the duty and responsibility of all property owners to maintain the grounds of maintenance strips on the owner's property, regardless of whether such property is developed. This maintenance shall include watering as needed and keeping such strips free from weeds or any obstructions contrary to public safety. Property owners shall be responsible for watering mature city street trees whenever landscaping of the property is changed in such a manner as to deprive the tree of its normal source of moisture. Such watering shall be continued during dry weather until the street tree becomes acclimated to the new environment, but need not exceed three years. All watering requirements shall be waived to the extent they are inconsistent with governmental restrictions on water use.*

*(b) It shall be the duty and responsibility of every person owning or occupying any real property within the City of Sacramento, to keep all trees on that property trimmed in such a manner that there is a clearance of at least fourteen feet above any street or alley, and a clearance of at least seven feet over any sidewalk. It shall also be the duty and responsibility of every person owning or occupying any real property within the City of Sacramento to keep all trees on that property trimmed in such a manner that they do not obstruct the view of any traffic sign or device for vehicle traffic in the direction controlled by that traffic sign or device.*

[Sacramento, CA: City Code Section 45.5]

*The owner or occupant of any corner lot or premises in the town shall keep trees, hedges and growth at the corners of intersecting streets, whether between the curb line and the private lot line, or within the private lot or premises, so trimmed that the height of the same shall not exceed three feet above the curb level for a distance of thirty feet measured horizontally in any direction from the point of intersection of the property lines at street corners; provided, that trees whose main trunks are exposed to a height of seven and one-half feet above the curb need not be so trimmed or cut.*

[Los Gatos, CA: Town Code Section 31-15]

*The duty is imposed upon a property owner to notify the parks and recreation department when any tree, palm, shrub or plant in a public street adjacent to his property is injuring or damaging any public sidewalk...*

[Carlsbad, CA: City Code Section 11.12.120]

## **22. Help for citizens performing tree maintenance**

**Purpose:** To assist citizens in meeting requirements mandated by the local government.

Key elements:

- Types of assistance to be provided
- Method of applying and qualifying for assistance
- Authority charged with granting assistance

**Notes:** Some street tree ordinances contain a provision which allows the city to assist citizens with street tree maintenance, if the citizen reimburses the city for the work it performs. The following example is typical of

such provisions.

*...On application of any person to whom there has been issued a permit to trim, prune or remove a tree from a City right-of-way, the City Engineer may trim, prune or remove such tree described in such permit provided the cost thereof is paid by the permittee and provided there shall first be deposited with the City Engineer a sum determined to be the estimated cost of such work. All such deposits shall be placed in a trust fund. Following completion of the work the City Engineer shall determine the actual cost of the work and transfer that portion of the deposit to the appropriate City fund and return the balance to the depositor. Should the original deposit be insufficient to cover the actual cost of the work the permittee shall be liable to the City for the unpaid balance and shall promptly pay such amount to the City upon demand of the City Engineer.*

[San Carlos, CA: City Code Section 6504]

The City of Visalia, California, tree ordinance authorizes the Director to require that citizens hire a professional to trim their oak trees. To offset this burden, the city provides financial assistance to help low income residents hire professional tree trimmers. The ordinance creates a special "Oak Maintenance Fund" to finance the assistance program. The fund derives its income from fines and penalties assessed for violations of the tree ordinance.

*If the Director determines that a property owner who has submitted a Notice of Intent to Prune an Oak Tree, cannot properly prune his or her Oak Tree without the assistance of a professional tree trimmer, and that said property owner cannot afford to hire a professional tree trimmer because he or she does not have the financial resources to pay for such services, the Director may provide financial assistance to said property owner for the purpose of pruning the tree or trees, if the following conditions are met:*

*(a) The property owner uses the property where the tree(s) are located as his or her principal place of residence;*

*(b) The aggregate gross income of all persons eighteen (18) years of age or older residing on the property does not exceed the minimum amount as may be set from time to time, by resolution of the City Council, pursuant to this subdivision; and*

*(c) The Director determines that it is necessary to prune the tree to remove hazardous conditions, remove disease, rot, pests, other harmful conditions, or promote healthy growth of the tree(s).*

*Such financial assistance shall include, but not be limited to, low interest loans, work done by the City with the cost borne in part or in whole by the property owner, work done by the City with the cost borne by the City to be repaid by the property owner upon such terms as the City and property owner shall agree, or any combination thereof.*

[Visalia, CA: Ordinance Code Section 2349]

## **23. Topping prohibited**

**Purpose:** To prohibit the practice of topping and/or other especially destructive maintenance practices in public and private trees.

**Key elements:**

- Definition of topping and other prohibited practices, if not included in provision 4 ([Definitions](#))
- Classes of trees covered by the provision

**Notes:** A community's investment in its tree resources, which are accrued over many years, can be rapidly squandered through poor tree maintenance practices even if the trees are not actually removed. Poor pruning practices such as topping (aka hat-racking, stubbing, dehorning), i.e., cutting back large diameter branches of a mature tree to stubs, are particularly damaging. The excessive removal of canopy associated with topping is often stressful to mature trees, and may result in reduced vigor, decline, or even death of the tree. In addition, new branches that form below the cuts are only weakly attached to the tree, and are in danger of splitting out. Topped trees require constant maintenance to prevent this from happening, and it is often impossible to restore the structure of the tree crown after topping. Unfortunately, many people believe that topping is a proper way to prune a tree, and this destructive practice is very prevalent in some communities. In such cases, a vigorous program of public education should be pursued in combination with the ordinance.

Ordinances that restrict topping may apply to public trees only, or may extend to all trees, both public and private, within the community. For example, the City of San Juan Capistrano, California, has detailed regulations regarding topping. The regulations define topping (as "severe trimming"), prohibit it in certain zoning districts, and describe the type of pruning which is to occur.

Rather than including detailed specifications in the ordinance itself, we recommend that the ordinance authorize the preparation, adoption, and enforcement of tree pruning standards by the tree program manager (see provisions 15 - [Designate administrative responsibilities](#) and 18 - [Develop a comprehensive management plan](#)). This allows for greater flexibility and easier updating of the standards when necessary.

*... "Severely trimmed" shall mean the cutting of the branches and/or trunk of a tree in a manner which will substantially reduce the overall size of the tree area so as to destroy the existing symmetrical appearance or natural shape of the tree in a manner which results in the removal of main lateral branches leaving the trunk of the tree in a stub appearances as shown is Exhibits A and B... ...No property owner or his agent in the Tourist Commercial, ... or any residential zoning district located within 500 ft of a scenic highway or drive ... shall cause any tree on his property to be severely trimmed ... ...The following standards identify trimming methods which will give maximum benefits to both trees and people:...*

[San Juan Capistrano, CA: City Code Section 9-3.625]

The following example includes selections from a portion of an ordinance that restricts topping ("hatracking") and several other destructive practices under the general term "tree abuse". The code includes specific definitions of what practices are and aren't prohibited, a mechanism for waivers and appropriate penalties, which include remedial maintenance or, if necessary, replacement (see also [provision 11](#)).

*(a) Declaration of intent. The city commission (city) finds and declares that regulation of the cutting, trimming, and pruning of trees within the city will help ensure that the health, function and value of trees are protected, and will help to prevent dangerous branching conditions that may result in danger or injury to citizens or property...*

*(a.3) Tree abuse means:*

*a. To hatrack a tree; or ...*

*c. Cutting upon a tree which destroys its natural habit of growth [as defined herein]; or*

*d. Pruning that leaves stubs or results in a flush cut; or splitting of limb ends; or*

*...*

*f. The use of climbing spikes, nails, or hooks, except for the purpose of total tree removal or as specifically permitted by the American National Standards Institute; or ...*

*(5) Violator means a person who abuses a tree or otherwise violates this section. The owner of property upon which the abused tree is located shall also be deemed a violator if the tree abuse is undertaken by the owner's employee, agent or person under the owner's control...*

*(b.1) No person shall abuse a tree unless one (1) of the following exemptions applies:*

*a. The abuse is necessary to alleviate a dangerous condition posing an imminent threat to the public or property,*

*b. Franchised utilities may obtain a permit from the city, renewable on an annual basis, authorizing the pruning of trees in a manner that may be defined herein as tree abuse provided such pruning is necessary to prevent service interruptions.*

*(b2) Any person may apply to the planning and development department for an administrative waiver from the terms of this section, provided that:*

*a. The application is made before any actions for which a waiver is sought have been undertaken;*

*b. Any alleged hardship is not self created by any person having any interest in the property. A hardship shall not be considered self created if the subject tree was installed prior to the effective date of this section;*

*c. There are unique and special circumstances or conditions applying to the subject tree or the property upon which it is located, that do not apply generally to other trees or properties.*

*d. The waiver proposed is the minimum variance necessary to alleviate the hardship.*

*e. That the granting of the waiver will be in harmony with the general intent and purposes of this section and will not create a dangerous condition that threatens the public or property.*

While it is probably impossible to construct a concise list of all the ways that trees may be damaged, restricting the most common damaging practices may be of value if combined with an ongoing campaign of public education on proper tree care practices. Another approach to improving tree care, targeted at individuals and firms that perform tree work for hire, is discussed under provision 28 - [Licensing of private tree care firms](#).

## 24. Permit required for planting trees in the public right-of-way

**Purpose:** To ensure that street tree selection and placement conforms with municipal standards.

**Key elements:**

- Permit process for planting in the public right-of-way
- Prohibition of planting in conflict with established standards
- Remedies to be applied in case of violation

**Notes:** In order to avoid future maintenance problems, conflicts with overhead utilities, and potential sidewalk damage, local governments usually reserve the right to control plantings in the public right-of-way. The tree program manager should be given authority over such plantings in provision 15 ([Designate administrative responsibilities](#)). Acceptable tree species and planting specifications should be described in the comprehensive urban forest management plan (see [provision 18](#)).

*No person shall plant any street tree except according to policies, regulations and specifications established pursuant to this chapter...*  
[San Luis Obispo, CA: City Code Section 12.24.130 F.]

*All trees planted in the public street or sidewalk area and all tree planting required by this code shall be located and planted under the supervision of the city forester, who shall supervise such planting and locating. In the performance of such work, consideration shall be given to the following factors; provided, that setbacks permit and considerations of safety do not interfere. These factors are determined to be of primary importance in maintaining the city forest.*

*A. Trees that must be removed shall be replaced by new planting, except in unusual circumstances.*

*B. Wherever feasible, trees shall be planted near old and dying ones in anticipation of their removal.*

*C. Unnatural regularity of spacing and arrangement shall be avoided; staggered, or irregular locations or a simulated forest arrangement being preferred.*

*D. Species selected may vary, depending on location; however, the preference of native species is urged; the Monterey pine is to be perpetuated as our dominant forest tree within the city.*



*E. The coordinating of tree planting on public ways with landscaping on private property so as to achieve the above purposes is deemed desirable.*

[Carmel-By-The-Sea, CA: City Code Section 12.28.230]

Although some ordinances require removal of any tree planted without a permit, it may be preferable to require removal of only those trees that do not conform with standards. Some jurisdictions will allow nonconforming trees to remain, but require the property owner to accept all financial responsibility for tree maintenance and damage that may be caused by the tree.

*Whenever any tree is planted or set out in conflict with the provisions of the Article, it shall be lawful for the Parks Superintendent to remove or cause removal of the same. The cost of removal of such tree may be charged to the property owner responsible for the planting thereof.*

[San Buenaventura, CA: City Code Section 8421.2]

If one of your goals is to encourage tree planting, the permit process for planting should be as simple as possible, and no permit fee should be charged. We highly recommend a program to educate the public on appropriate tree selection and siting for local conditions to complement this provision. It is more productive to spend time and effort encouraging proper tree selection and planting than removing offending trees.

## 25. Planting requirements

**Purpose:** To ensure appropriate tree planting in new developments, including parking lots.

### Key elements:

- Performance standards for tree planting and maintenance during establishment
- Designation of responsibility for planting and maintenance
- Protocol to ensure that planting complies with the comprehensive management plan (see [provision 18](#)) or other standards
- a mechanism to provide for monitoring of tree establishment unless specifically addressed elsewhere (e.g., [provision 13](#))

**Notes:** Some communities include tree planting requirements in a separate landscape ordinance, or in the zoning code under various development standards. However, in many cases, tree planting requirements are appropriately placed in the tree ordinance or at minimum should be cross-referenced in the tree ordinance. It is very important that basic performance standards be set in this provision. The provision can specify minimum tree densities (e.g., numbers of trees per street mile) or canopy standards (e.g., amount of canopy cover or shading to be provided within a set period of years). The tree program manager should then be given the latitude to develop appropriate implementation standards and approve specific plans.

Responsibility for planting and maintenance varies by community. If developers do not perform the actual planting, they are normally required to pay in-lieu fees and tree planting is handled by the local government.

The building permit approval process is frequently used to ensure compliance with tree planting regulations. Communities may withhold occupancy permits until trees have been satisfactorily installed, and require performance bonds to ensure establishment. Performance bonding should be for at least three years to guarantee good long-term survival. Furthermore, unacceptable tree growth or condition, as well as actual tree



death, should be grounds for bond forfeiture. Trees that are of poor quality when planted or are maintained poorly may not actually die within three years, but their future survival and performance may still be unacceptable.

*No subdivision shall be approved unless it is found to include planting of official, approved street trees within the adjacent parkways in conformity with the Street Tree Management Plan and under the Director's supervision...*

*In-lieu fees, which are established by resolution of the City Council, may be deposited by the developer or applicant upon the recommendation of the Director. In cases when a subdivision is being approved, and the building process may be over a prolonged period of time, in-lieu fees may be required...*

*In the event a subdivider desires to plant trees within the parkway adjacent to a new subdivision, he may apply to the Director for a permit. Such permit may be issued by the Director only after the subdivider has posted a bond pursuant to Chapter 2.17 of this Code, guaranteeing the planting of all street trees, and paid the estimated cost of all irrigation and maintenance for a three-year period. All such planting shall be done in accordance with the Street Tree Master Plan, as shall any necessary replanting which would be required should any of the planted trees die within [or be deemed unacceptable by the Director at the end of] the three- year period.*

*The costs of planting and the first three years of maintenance, including irrigation, of all street trees in a new subdivision, shall be borne by the subdivider. The Director shall determine the cost involved for each subdivision, which shall be paid to the City prior to City Council approval of the final map of the subdivision. The Director shall plant, maintain, and irrigate such trees at such times and places as the development of the subdivision, its occupants, and other conditions make feasible.*

[Carpinteria, CA: City Code Section 12.28.160]

*B. Before planting, all street trees must be inspected and approved by the city arborist or his designee...*

*F. So the city arborist can determine the tree requirements for site development, any subdivider or developer shall submit to the city a plot plan of the proposed subdivision which shall:*

- *1. show clearly all existing trees, noting location, species, diameter and condition*
- *2. note whether existing trees will be retained, removed or relocated*
- *3. show proposed utilities, driveways, street tree locations, and the size and species of proposed street trees.*

[San Luis Obispo, CA: City Code Section 12.24.100]

## Parking lot shading provisions

Especially in warm climates, unshaded parking lots become extremely hot, contributing to both the urban heat island effect and increased air pollution through enhanced volatilization of reactive hydrocarbons from parked vehicles ([Scott et al 1999](#); [Center for Urban Forest Research 2001a](#)). Hence, many communities require that newly constructed or reconstructed parking lots be shaded by incorporating tree plantings into the parking lot design. Requirements for tree planting in parking lots are sometimes enacted through a specific parking lot shading ordinance, but the code may be incorporated into the city code related to trees, landscaping, parking lots, or elsewhere.

### Key elements:

- basic performance standards related to the amount of shade or tree planting required. The most common types of standards include:
  - shading standards based on the amount of shade to be provided by trees after a set period of time, such as 50% of pavement shaded in fifteen years.
  - minimum distances from any parking stall to a tree,
  - tree to parking stall ratios
  - minimum landscaped area as a percent of paved area in conjunction with tree density standards in the landscaped area.
- methods used to calculate tree shading and determine the amount of shaded and nonshaded area to be counted in calculations or assess tree planting ratios provided on parking lot plans
- person or body responsible for determining that a plan complies with the standards
- a mechanism to provide for periodic monitoring of parking lots to assure that tree maintenance is adequate and that standards are met

Based on their analysis the [Center for Urban Forest Research \(2001b\)](#) notes several additional factors that should be considered when developing parking lot tree shade ordinances. These include:

- provisions to deal with the common conflicts between parking lot trees and business signage and parking area lighting

- refining calculations for tree shade provided in the plan to include only partial credit for trees that are located on the periphery of the lot because only a portion of the canopies of these "edge" trees actually shades pavement

- requirement that removed trees be replaced according to a replacement schedule based on equivalent size or value

- funding compliance monitoring through fees paid at the time of construction.

As discussed under the special topic [Evaluating parking lot shading](#), the success of parking lot tree shade provisions depends on good implementing regulations or guidelines. The [Center of Urban Forest Research \(2001b\)](#) suggests guidelines for tree planter size, irrigation, and planting methods to ensure good tree growth. Local empirical data on tree growth in parking lots is needed to develop realistic estimates of tree canopy cover after various time intervals. Technical information and specifications, such as lists of tree species and their respective canopy spread after a set number of years, examples of shade calculations, and construction details, are needed to implement this and other planting provisions. However, these technical details are better placed in accompanying guidelines and regulations. Inserting such technical details into the ordinance

code not only clutters it unduly, but can interfere with routine updating needed to keep specifications up to date.

Finally, even with monitoring, the ordinance must provide for enforcement of the provision, either as part of the provision or under a synoptic enforcement provision ([provision 12](#)). Enforcement is somewhat problematic because the party that submits the original planting plan is typically not the eventual owner of the parking lot, and ownership of the lot may change periodically. Hence, one enforcement method (e.g., withholding of occupancy permits) may be appropriate for the planning stage whereas another enforcement method (e.g., fines, abatement orders) may be appropriate for the long-term maintenance of required plantings.

*At least 50% of the paved area surface [of parking areas] shall be shaded by tree canopies within 15 years of acquisition of building permits. Trees to be planted to develop such a canopy shall be in accordance with the City's Master Street Tree Plan and the requirements of the Director of Parks and Trees. Plans submitted to the Development Review Board shall show the estimated tree canopies after 15 years of growth, the specific names, sizes and locations of trees to be planted, and the total area in square feet of the area shaded by tree canopies. In determining the area shaded, the following methodology shall be used:*

- *i. Measure the shaded area on the pavement assuming that the shaded area is only that area directly under the tree canopy or dripline.*
- *ii. Landscape planters under the canopy may be counted as shaded area.*
- *iii. Paved areas shaded by structures (such as second stories of buildings, carports) may be deducted from the total paved area.*

[Oroville, CA: City Code Section 26-49.k.10]

*Tree Shading. Trees shall be planted and maintained throughout the surface parking lot to ensure that, within fifteen (15) years after establishment of the parking lot, at least fifty (50) percent of the parking area will be shaded.*

*1. Surface Parking Lot. Except as provided below, all surfacing on which a vehicle can drive is subject to shade calculation, including all parking stalls; all drives within the property, regardless of length, and including drive-through lanes; and all maneuvering area, regardless of depth. The following surfaced areas are exempt from this shade requirement: (i) truck loading area in front of overhead doors; (ii) truck maneuvering and parking areas unconnected to and exclusive of any vehicle parking; (iii) surfaced areas not to be used for vehicle parking, driving or maneuvering, provided they are made inaccessible to vehicles by a barrier such as bollards or fencing; (iv) automobile dealerships, display/sales/service/vehicle storage areas (required parking for auto dealerships is still subject to shading); and (v) existing surfaced areas.*

*2. Shading. Shading should be calculated by using the diameter of the tree crown at fifteen (15) years. Each planting area shall be of adequate size for the landscaping approved and shall have adequate irrigation for that landscaping. All landscaping (trees, shrubs, and turf) in these planting areas shall be properly*

*maintained. The city landscape architect shall establish a list of species appropriate for providing shade in parking lots, and shall review site plans of each parking lot to determine whether or not the lot complies with this chapter. Trees planted in order to comply with the regulations of the chapter shall be selected from the list prepared by the landscape architect. The city landscape architect shall have the discretion to modify tree shading requirements under power lines and other obstructions which prohibit strict compliance with shading requirements, and to give shading credit for photovoltaic arrays, off-site trees and structures, sidewalk canopies, and other structures, where appropriate.*

[Sacramento, CA: City Code Section 17.64.030.H.]

*(d) Interior parking areas shall be landscaped in addition to the required landscaped strip. Trees must be provided in each parking lot at a minimum average density of one (1) shade tree (three inch caliper minimum) for each fifteen (15) parking spaces provided, or any fraction thereof. In the case of mini warehouses, such parking spaces shall be determined by the number of parallel parking spaces contained in the required loading and unloading lanes. Additionally, interior parking lot landscaping shall be provided in accordance with the following table...*

<b>Total Parking Area</b>	<b>Interior Landscape Area</b>
0 - 24,999 square feet	5%
25,000 - 49,999 square feet	8%
50,000 square feet and larger	10%

*(e) Except for customer and employee parking, parking lot landscape requirements do not apply to storage or standing parking spaces incidental to uses, such as sales and rental of motor vehicles, mobile homes, boats, trailers or other similar uses.*

*(f) To calculate the total parking area and the subsequent percentage of required interior lot landscaping, total the square footage of parking spaces, planting islands, curbed areas and all interior driveways and aisles except those with no parking spaces located on either side. Landscaped areas located outside the parking lot may not be used to meet the interior landscaping requirement.*

*(g) The required landscaping for parking lots shall be more or less evenly distributed throughout the parking lot, although adjustments may be approved by the Community Development Department where the shape or size of the parking lot, the location of existing trees or other natural constraints reasonably prevent such distribution.*

*(h) All landscaped areas, including the permeable areas and drip lines around trees and planting beds used for visual screening which abut any parking lot or*

*vehicular travel area, shall be protected with curbs, parking blocks or similar barriers sufficient to protect them from vehicular intrusion.*

*(i) An automatic irrigation system is required for all landscaping. Water conservation is encouraged.*

[Lewisville, TX General Development Ordinance Sec 6-103]

What levels of parking lot shading are realistic to include in a parking lot shading provision? The answer depends not only on the eventual size that trees will attain under parking lot growing conditions but on the amount of space set aside as growing space for trees. We used [Peper et al's](#) empirical crown projection data numbers to calculate how much of the interior paved area of a parking lot would need to be set aside for trees in order to reach a 50% pavement shading goal after 15 years. We made the following assumptions in these calculations;

Landscaping consists of shade trees individually planted in 6 foot by 8 foot planter islands located within the parking lot (i.e., all of the trees' canopy is over the parking lot).

The shade trees used reached an average crown diameter of 21 ft after 15 years (according to [Peper et al](#), this is the average size of London plane trees in Sacramento, CA, parking lots after 15 years).

Planting islands are configured so that there is no overlapping shade from adjacent trees

All planted trees survive and trees are not topped or otherwise pruned to reduce tree canopy development

Canopy over the planters counts toward the 50% shading requirement even though planters are not actually paved areas.

<b>Percent of interior paved area occupied by 6 ft by 8 ft planters (1 tree/planter)</b>	<b>Projected parking lot shading after 15 years (average crown diameter= 21 ft)</b>
5% of paved area	35%
7% of paved area	49%
10% of paved area	70%

If we assume that trees are also planted at the edge of the parking lot to provide at least partial shading, less than 7% of the parking lot are would need to be devoted to tree planters to reach 50% shading in 15 years, again assuming that fast-growing trees with relatively large crowns are used. If tree crown diameter is only a bit smaller after 15 years (17.5 ft), a full 10% of the paved area will be required for tree planters to attain 50% canopy. Good data on actual sizes trees attained in parking lots under local growing conditions are essential for developing planting specifications that will result in desired levels of canopy cover. Further information and technical considerations related to parking lots and shade trees can be found at Center for Urban Forest Research website at <http://wcufr.ucdavis.edu/parkordinances.htm>.



## Ordinance provisions for specific goals (Provisions 26-32)

---

<b>Number</b>	<b>Provision</b>	<b>Goals</b>
16	<a href="#">Establish a tree board or commission</a>	6,8
17	<a href="#">Specify cooperation between departments and agencies</a>	6,7
18	<a href="#">Develop a comprehensive management plan</a>	1,2,3,4,5,7
19	<a href="#">Resolution of conflicts between trees and structures</a>	1,2,4
20	<a href="#">Exemption from Solar Shade Control Act (California)</a>	1
21	<a href="#">Responsibilities of property owners</a>	5
22	<a href="#">Help for citizens performing tree maintenance</a>	2,8
23	<a href="#">Topping prohibited</a>	2
24	<a href="#">Permit required for planting trees in the public right-of-way</a>	5
25	<a href="#">Planting requirements</a>	1,2,3,4,5
26	<a href="#">Situations which are declared to be public nuisances</a>	2
27	<a href="#">Abatement of hazards and public nuisances</a>	2
28	<a href="#">Licensing of private tree care firms</a>	2
29	<a href="#">Harming public trees forbidden</a>	2
30	<a href="#">Permit required for activities that may damage city owned trees</a>	1,2,4,5
31	<a href="#">Permit required for activities that may damage protected private trees</a>	1,2,4
32	<a href="#">Conservation of forest and woodland resources during development</a>	1,3,4
33	<a href="#">Procedures to be followed in resolving tree disputes</a>	9
34	<a href="#">Standards for resolution of tree disputes</a>	9
35	<a href="#">Apportionment of tree dispute resolution costs</a>	9
36	<a href="#">Recording for notification of future owners</a>	9
37	<a href="#">Enforcement of tree dispute resolutions</a>	9

## 26. Situations which are declared to be public nuisances

**Purpose:** To define unacceptable situations which are subject to abatement by the local government.

**Notes:** Conditions and situations that jeopardize public health and safety are most commonly declared to be public nuisances. Hazardous trees and trees which obstruct travel or line of sight may fall into this category. Situations that threaten the health of the urban forest or are contrary to the community forest management strategy may also be declared nuisances. This second category includes trees which harbor diseases or insect infestations that may readily spread to adjacent trees and species which are considered undesirable. Improper maintenance practices which can lead to tree death or disfigurement have also been declared to be public nuisances in some communities. Abatement procedures are typically contained in a separate provision (see provision [27 - Abatement of hazards and public nuisances](#)).

*A. Any tree, shrub or groundcover, growing or standing on private property in such a manner that any portion thereof interferes with any public street, sidewalk, alley or restricts the flow of traffic or visibility of such street, sidewalk, alley or intersection thereof to any person or persons lawfully using such streets, sidewalks, alleys or intersections shall constitute a public nuisance.*

[La Habra, CA: City Code Section 12.20.100A]

*The following things are public nuisances whenever they may be found within the City of Sacramento:*

*(a) Any living or standing elm tree or part thereof infected to any degree with the Dutch Elm Disease fungus, Ceratocystis ulmi (Buisman) Moreau [the name is now Ophiostoma ulmi (Buisman) Nannf.]; or which harbors any of the elm bark beetles, Scolytus multistriatus (Marsh.) Or Hylurgopinus rufipes (Eich.);*

*(b) Any dead elm tree or dead part of any elm tree, including logs, branches, stumps, firewood or other elm material from which the bark has not been removed.*

[Sacramento, CA: City Code Section 45.102]

*It is hereby declared a public nuisance for any person owning, leasing, occupying, or having charge of any premises in the City of Visalia which has one or more Oak trees located thereon to intentionally, negligently, accidentally, or otherwise maintain said premises in such a manner so as to cause harm to and of said Oak trees, by reason of any of the following conditions.*

- *1. Water saturation or deprivation;*
- *2. Nailing, screwing, stapling, bolting, or otherwise attaching boards, fences, signs, placards, posters, or any other material which might cause injury to the Oak tree;*
- *3. Neglect in the pruning or trimming of overgrown, diseased, decaying, dead, or rotting limbs, branches, and foliage.*

[Visalia, CA: Ordinance Code Section 2356]

## 27. Abatement of hazards and public nuisances



**Purpose:** To set forth procedures for abating the public nuisances described in provision [26 \(Situations which are declared to be public nuisances\)](#).

**Key elements:**

- Authority to determine nuisance (if not noted in provision 15-[Designate administrative responsibilities](#))
- Procedure for notification and appeal, including time limits
- Method of abatement and assessment of costs incurred

**Notes:** Communities vary in the detail to which they prescribe the procedures which must be followed for nuisance abatement and assessment of associated costs. Notification and appeal procedures may be simple or involved.

*... upon a determination by the Park Superintendent that such a private tree constitutes a public nuisance, he shall give written notice to the owner of the property upon which said nuisance exists to trim, remove, or otherwise control such tree in such a manner as will abate such nuisance. Failure to comply with such written notice within ten days thereafter, is a violation of this section...*

[Patterson, CA: City Code Section 12.16.120]

*... The City may remove or trim such tree, may permit any public utility to do so, or may require the property owner to remove or trim such tree on private property or on a public parking strip abutting upon the property of the owner. The failure of the property owner, or his duly authorized agent, to remove such tree after fifteen (15) days notice by the City Superintendent shall be deemed a violation of the provisions of this chapter, and the City Superintendent may then remove or trim such tree and assess the cost thereof against the property.*

[Fowler, CA: City Code Section 7-1.08]

## 28. Licensing of private tree care firms

**Purpose:** To improve care of private trees by ensuring that firms performing tree maintenance are qualified and have appropriate liability insurance coverage.

**Key elements:**

- Types of tree maintenance that require special licensing
- Requirements for professional qualifications
- Liability insurance requirements
- Method of documentation
- Authorization to suspend or revoke licenses for violations

**Notes:** Improperly performed tree maintenance work, including pruning, cabling, and removal, can cause property damage and endanger public health and safety. Therefore, many community tree ordinances require that firms engaged in tree work carry liability insurance.



*Any person, firm or corporation engaged in the business of removing City trees shall carry public liability and property damage insurance in an amount to be determined by the city council and policies or certificates thereof shall be filed with the city clerk. Where deemed advisable, the Director may require the posting of a performance bond pursuant to Chapter 2.17 of this code to guarantee the completion of any job in accordance with adopted City Standards, rules and regulations.*

[Carpinteria, CA: City Code Section 12.28.240]

Many jurisdictions require proof of insurance and professional qualifications only of firms performing work for the local government. Others, as shown below, extend insurance requirements to all tree service firms operating within the community.

*Any person engaged in the business of pruning, trimming or removing of trees in the City of Escalon, shall secure an annual permit to so from the City Administrator. This permit is in addition to all other business licenses required by Ordinance No. 24 as amended of the City of Escalon. ... As a condition to obtaining said permit, the person shall furnish satisfactory proof to the City Administrator that he has public liability insurance covering said pruning, trimming, or removing trees, in minimum amounts ... as established by the Council by resolution. The policy or policies of insurance, or certificates thereof, shall be filed with the City Administrator, prior to the issuance of said license, and such person shall keep said insurance in full force and effect during the term of the permit.*

[Escalon, CA: City Code Ordinance 147 Section 12]

Furthermore, improper pruning practices can irreparably disfigure and harm trees. In the interest of protecting community tree resources, it is reasonable for the local government to require proof of professional competence from those performing tree work for hire. Such proof might take the form of certification from the [International Society of Arboriculture](#), completion of course work and training in arboriculture, passing an examination, or other criteria.

*When the city requires tree pruning, any tree service contractor performing work shall have on its staff an arborist certified by the Western Chapter of the International Society of Arboriculture. This arborist must oversee all pruning work and certify that all work meets the city's pruning specifications. If a certified arborist is not on the staff of the tree contractor, the city arborist must approve the tree service contractor before work begins.*

[San Luis Obispo, CA: Municipal Code Section 12.24.160]

As part of the license requirement, the local government can also require that tree care firms abide by the requirements of the tree ordinance and by tree care standards incorporated by reference in the ordinance, as in the following example.

*It shall be unlawful for any person who is being paid a fee for the business of planting, cutting, trimming, pruning, removing, or otherwise modifying trees within the City of Myrtle Beach to conduct such business without first signing an affidavit stating that he/she has received and read the Tree Protection Ordinance and [most recent] ANSI A300 Standards [and that all work performed will consistent with these documents]. Such affidavit shall be completed and submitted when making application for or renewing a City of Myrtle Beach business license.*

...

*Tree pruning shall be accomplished in accordance with the procedures set forth in the [most recent] ANSI A300 standards.*

[Myrtle Beach, SC: Municipal Code Section 903.4, 903.12.1]

The example code below requires tree care licensing, authorizes the city arborist to manage and enforce the licensing program under the review of the city tree commission, and requires licensees to abide by city standards and ordinances.

*It is unlawful for any person or business to perform tree pruning and repair work (as defined in Section...) for hire within the city without a valid tree care license issued by the city arborist. Each tree pruned or otherwise modified in violation of this provision shall constitute a separate offense. The first such offense is punishable by a fine not to exceed \$500; each subsequent offense is punishable by a fine not to exceed \$1000 dollars. No maximum fine is established for multiple violations by a single person or business.*

*The city arborist is authorized to issue tree care licenses to persons or businesses that meet the following minimum requirements:*

- 1. The person or at least one person on the staff of a business must be designated as a Qualified Arborist by the city. To be designated as a Qualified Arborist, a tree service employee shall demonstrate a knowledge of proper arboricultural techniques by providing documentation of professional certification, education, and/or experience acceptable to the city arborist.*
- 2. The licensee must sign an affidavit to certify that all tree work will be performed under the direct supervision of the Qualified Arborist and will comply with all city standards and ordinances.*

*The city arborist is authorized to suspend or revoke the tree care license of any person or business that performs work which does not comply with tree care standards as specified in this chapter and in the comprehensive tree management plan. License suspensions and revocations may be appealed to the city tree commission within 10 days of notification. The decision of the city tree commission shall be final and is not subject to appeal.*

*The city arborist may reissue any tree care business license previously revoked subject to the above minimum requirements and any additional requirements as may be prescribed by the city arborist and approved by the city tree commission.*

## 29. Harming public trees forbidden

**Purpose:** To prohibit negligent or intentional damage to trees and other plants growing in the public right of way.

**Key elements:**

- Designation of which trees and other plants are protected
- Prohibited activities and actions

**Notes:** This is one of the most common provisions in street tree ordinances. It is primarily targeted at preventing vandalism and negligent damage. Some ordinances have elaborate lists of many different ways which trees can be harmed. Others include prohibitions against fastening animals to trees and allowing animals to browse trees. Some ordinances extend protection to tree guards or supports as well as to trees. If damage is properly defined in the definitions section (see [provision 4](#)), it may be possible to cover all types of damage rather simply, and avoid long (and often incomplete) litanies of damaging practices. Legal staff should be consulted in this regard.

*It shall be a violation of the provisions of this Chapter for any person to abuse, destroy or mutilate any tree, plant or shrub in a public parking strip or any other public place, or to attach or place any rope, wire (other than one used to support a young or broken tree), sign, poster, handbill or other things to or on any tree growing in a public place, or to cause or permit any wire charged with electricity to be placed or attached to any such tree, or allow any gaseous, liquid or solid substance which [is] harmful to such trees to come in contact with their roots, [trunks,] or leaves.*

[Corcoran, CA: City Code Section 2-4-9]

## 30. Permit required for activities that may damage city owned trees

**Purpose:** To provide for municipal review and approval of any activity which could be detrimental to public trees.

**Key elements:**

- Activities that require a permit
- Position with authority to issue permits (if not noted in provision [15 - Designate administrative responsibilities](#))
- Guidelines for approving or denying permits, including conditions that may be required to prevent or compensate for damage
- Permit application and appeal procedures, including time limits

**Notes:** In order to safeguard the public investment in street trees and other public trees, many local

governments reserve the right to regulate a variety of potentially damaging activities. The authority to approve regulated activities should normally be vested with the tree program manager. Each community needs to decide what activities it will regulate. Some of the activities that might require a permit include:

- tree removal,
- pruning,
- grading or trenching near trees,
- installation of pavement over tree rootzones,
- transport of buildings or other large items which could break city street tree branches.

To prevent a net loss of trees, all trees removed should be replaced in a manner consistent with the overall tree management plan. If a community's goals include [conservation of tree resources](#) and [establishment of maximum canopy cover](#), guidelines for approving tree removal permits should clearly establish the precedence of trees over hardscape or turf (see also provision 19 - [Resolution of conflicts between trees and structures](#)).

*A. No person, unless expressly authorized hereunder, shall plant, remove, cut, trim, or prune, any street tree or any tree, plant, or shrub in a city park or other public place without a permit issued by the Director of Public Works. Such permit application shall be made at least 2 working days before the intended activity. The Director of Public Works may grant the permit or grant a permit on conditions when such is consistent with the provisions of this chapter, the Master Street Tree Plan, and other applicable laws and public policy. No such permit shall be valid for a period greater than 30 days after the date of its issuance.*

*B. In the case of moving a building along a street, such permit conditions may include rerouting, segmenting of such structure, and payment by applicant of attendant costs attributed to trimming or cutting authorized under such permit.*

[Pasadena, CA: Municipal Code Section 8.52.080]

*(a) The director shall issue permits to property owners to perform maintenance on or to remove city street trees, only if the following conditions are met:*

- *(1) The property owner has established, to the director's satisfaction, that there is need for the proposed work on the tree; and*
- *(2) The property owner has established, to the director's satisfaction, that the persons who are to perform the work are qualified to do so; and*
- *(3) The director, in his sole discretion, has determined that any potential detriment to the city street tree population entailed by the proposed work, is justified in the individual case. In making this determination, the director shall consider factors such as the probability that the proposed work will destroy or seriously injure the tree, the tree's health, the desirability of that species as a street tree, whether the tree's condition and size threaten serious damage to property, the condition and number of other city street trees in the vicinity, whether there are other less onerous means of accomplishing the applicant's goals, and other related criteria.*

*(b) All work performed on city street trees pursuant to a permit issued by the director under this section shall be done within a sixty day period from the issuance of said permit, or within such longer period as the director shall specify.*

*(c) The director shall condition any permit granted pursuant to this section for the removal of a city street tree, on the permittee removing, and where the director determines to it be appropriate, replacing the tree. In such case, the full cost of removal and replacement shall be borne by the owner and such service shall not be provided by the city.*

*(d) The director may condition any permit granted pursuant to this section on any such conditions as the director determines to be necessary.*

*(e) The provisions of Sec. 45.12 shall be complied with whenever a property owner seeks a permit to remove or trim a city street tree to facilitate moving any building or other structure.*

[Sacramento, CA: City Code Section 45.7]

As part of the procedure for granting tree removal permits, some communities require that a notice be posted or published in the newspaper.

*The city shall post a sign notifying the public of the date and description of a proposed tree removal. The sign shall be posted in a prominent location, visible from a public street, for a period not less than five days before either staff consideration of a tree removal permit or a public hearing on a related development.*

[San Luis Obispo, CA: Code Municipal Code Section 12.24.180F]

In some communities, local public utilities may be given a yearly permit that allows them to prune public street trees. In such cases, the local government should set minimum pruning standards and provide for inspection to enforce these standards.

*When maintaining street trees, a public utility must observe good arboricultural practices, as specified by the International Society of Arboriculture Western Chapter Pruning Standards and the City of San Luis Obispo Safety Pruning Specifications.*

[San Luis Obispo, CA: Municipal Code Section 12.24.140]

*...Public utility companies subject to the jurisdiction of the California Public Utilities Commission may perform such pruning as is necessary to comply with the safety regulations of said commission and to maintain a safe operation of their facilities without a permit. However, they shall notify the planning department at least three working days (except in emergencies) prior to taking any action. The planning director shall cause such pruning work to be inspected, when appropriate, to insure that good pruning practices previously referenced are followed. The planning director shall have the authority to stop any tree-pruning performed by a utility if such practices are not being followed...*

[Corte Madera, CA: City Code Section 15.50.040]

## **31. Permit required for activities that may damage protected private trees**

**Purpose:** To protect designated individual trees on private property from indiscriminate removal and damage.

**Key elements:**

- Classes of trees protected
- Activities subject to regulation
- Criteria and standards for approving regulated activities
- Permit process, including requirements, fees, time limits, and appeals
- Conditions or compensation required to mitigate for adverse impacts
- Monitoring of protected trees and mitigation areas

**Notes:** This type of provision is typically known as a [heritage or landmark tree](#) protection provision. It is best suited to protecting conspicuous individual trees that are of unique historical, ecological, or aesthetic value, and therefore constitute an important community resource. A mature tree is a significant community resource that required many years to develop and can provide community benefits for generations, but can be destroyed in as little as a few minutes. This is the main reason that trees may be provided a higher level of legal protection than is usually afforded to other plants in the urban landscape.

Although trees can be long-lived, the life spans of individual trees are still limited, especially in the urban environment. Hence, this type of provision may not address the long-term sustainability of the urban forest. Furthermore, because of its focus on individual trees, this type of provision may not be appropriate or effective for protecting woodlands and forests. Woodland or forest conservation is addressed in provision 32 ([Conservation of forest and woodland resources during development](#)).

Provisions that regulate private trees are unlikely to be effective without community support. Unless residents strongly support tree protection, it is probably advisable to link tree protection with some sort of benefit or incentive to balance the additional burden imposed by the provision. The local government might provide tree care assistance, consulting, reduce certain assessments, or institute a recognition program to provide a tangible benefit to owners of protected private trees. Education and incentive programs are needed to ensure that protected trees are seen as an asset rather than a liability.

If your community is interested in preserving native trees, you may want to consider options beyond limiting tree removal on private property. For example, you might consider a policy which calls for planting native trees in public places (see provisions: 7 - [Policies regarding trees](#), 24 - [Permit required for planting trees in the public right-of-way](#), and 25 - [Planting requirements](#)).

**Classes of trees protected.** Private tree protection regulations are commonly directed toward desirable, long-lived locally native trees and/or trees of historical significance. Most commonly, protected trees are designated by species, size, and/or location, although other criteria may also be used (see [Defining special trees: heritage, historic, and landmark trees](#)). These criteria should take into account differences between species and the influence of local environmental conditions on tree growth rates.

One disadvantage of using a size criterion is that some property owners may elect to remove trees before they grow large enough to come under the protection of the ordinance. This is obviously a counterproductive situation, since it has the effect of destroying future tree resources. Unfortunately, this behavior has been observed in various communities. If the goal of the community is to protect woodlands or forests, rather than individual trees, a [forest/woodland protection provision](#) (see provision 32) may be more appropriate. In some communities, both types of provisions may be needed to address the range of situations involved. If both individual tree and woodland protection provisions are used in the same ordinance, ordinance language must

be clear as to which provision applies to a given tree or group of trees.

Some communities apply tree protection provisions only to commercial properties by exempting single-family residential parcels. This may greatly limit the impact of the provision because most of a community's trees are typically located on residential parcels. On the other hand, if tree loss and poor tree care in commercial districts are serious problems in a community, focusing the provision on those problem areas may be appropriate.

In the following example, the various classes of protected trees are clearly stated. Another example is included on the [Defining special trees: heritage, historic, and landmark trees](#) page. It is important to grant protected status to trees planted or retained in compliance with the ordinance to establish a basis for long-term protection of tree canopy.

*The city hereby declares that the following are protected trees:*

*(1) Trees planted or retained to meet the Landscape Ordinance (Section 910) requirements;*

*(2) Wax Myrtles (*Myrica cerifera*) and Crape-Myrtles (*Lagerstroemia indica*) designated as "tree forms" or used to fulfill tree requirements on approved landscape plans or greater than 10 feet in height;*

*(3) Any tree over 3" caliper located on city-owned property including any public right-of-way;*

*(4) Any Sycamore (*Plantanus occidentalis*) and Sweet-Gum (*Liquidambar styraciflua*) with a 12" DBH or greater;*

*(5) Any Pine (*Pinus*) with a 18" dbh or greater (except Japanese Black Pine with a caliper of 2" or more);*

*(6) Indigenous trees, as defined in 903.3(12); and*

*(7) All other species of trees that are 5" or more in caliper.*

[Myrtle Beach, SC: Municipal Code Section 903.5]

Especially in urbanized areas, established trees are commonly threatened whenever property ownership changes. New property owners often do not understand or appreciate how trees on the property function in the landscape. In their zeal to make their mark on their newly-acquired properties, new landowners may quickly remove or inappropriately prune trees, or undertake landscape renovation projects that seriously damage tree roots and lead to the decline of established trees. If trees on only a few parcels each year are impacted by zealous but uninformed new owners, the cumulative effect on the community's mature tree population can be substantial.

The tree protection provision could be used to help reduce unnecessary tree damage by new property owners. The ordinance could extend protected tree status to virtually all trees on a property that has just changed ownership for a limited period, preferably at least one full year. By living with a tree for a full year and seeing how it functions in the landscape, property owners can make better decisions about managing the trees that have been passed down to them by previous owners. Furthermore, establishing a temporary moratorium on tree removal and other damaging activities provides a window of time during which the local government or a community tree group could try to educate new owners about tree values and proper tree care.



*Protected trees shall include...*

*All trees with a caliper of one inch or greater (measured 4.5 feet above grade) on properties for which a change in ownership has been recorded within the previous 15 months.*

[Example code by the authors]

Many tree protection provisions also provide specific exceptions that are not covered by the ordinance, as in the following example.

*b) Exemptions. A permit is not required to cut or remove a tree(s) under the following circumstances:*

*(1) Trees that do not exceed two inches (2") in diameter when measured at a point four and a half feet (4.5') above the tree's natural grade.*

*(2) Trees damaged by thunderstorms, windstorms, floods, earthquakes, fires or other natural disasters and determined to be dangerous by a peace officer, fireman, civil defense official or code enforcement officer in their official capacity. The Department of Planning and Community Development shall be promptly notified of the nature of the emergency and action taken.*

*(3) When removal is determined necessary by fire department personnel actively engaged in fighting a fire. (4) Trees planted, grown and/or held for sale as part of a licensed nursery business. This exemption is limited to trees with main trunks under ten inches (10") in diameter.*

[Thousand Oaks, CA: Municipal Code Section 5-14.04]

A potentially adverse impact of a rigorous tree protection provision is that property owners may be discouraged from planting "temporary" trees for fear that they will later be restricted from removing these trees. "Temporary" trees may be used in the landscape for several legitimate reasons. For example, fast-growing, less desirable trees may be planted to provide shade or visual screening over the short term while more desirable, slower-growing "permanent" trees are developing. Also, areas may be overplanted to achieve more rapid screening or cover. Extra trees in such dense plantings often require thinning at some point to reduce competition between trees and promote good growth. In order to encourage tree planting on private property, it is reasonable to allow an owner to remove any tree on their property that they had planted of their own volition.



*Any trees that exceed two inches in diameter when measured at a point four and a half feet above the tree's natural grade shall be exempt from the protection requirements of this ordinance (Section...) under the following circumstances:*

*(1) The property owner provides evidence acceptable to the Director that the tree has been planted by the owner during the period of his or her ownership of the property, and that the planting was not required by the city under Sections.... Evidence may consist of dated photographs, dated receipts, and/or other documentation acceptable to the Director. At the Director's discretion, the Director or authorized agent may inspect the tree to verify information provided by the property owner.*

[Example text by the authors]

**Activities subject to regulation.** In many jurisdictions, protection of trees on private property is limited to situations involving development or construction on a parcel. In these situations, tree protection is tied to the issuance of construction-related permits, a process over which the local government can readily exercise some control. However, if protection is provided only during construction, long-term tree survival may not be guaranteed. In many instances, considerable efforts have been made to protect trees during the development process, including project redesign, only to have "protected" trees removed or seriously damaged by the subsequent property owner.

To avoid this pitfall, some communities extend protection generally to certain classes of trees whether or not construction permits are involved. In the following example, a permit is required to perform any activity that may damage protected trees. Relatively few local governments actually allocate the resources necessary to monitor and cite violators that illegally damage or remove trees on private properties. More commonly, such provisions rely on education of the public and are largely enforced on a complaint basis. Hence, such provisions normally require a high level of community support and voluntary compliance to be successful.

*a) No person shall cut, remove, encroach in the protected zone, or relocate any oak tree on any public or private property within the City unless a valid oak tree permit has been issued by the City pursuant to the provisions of this chapter and the Oak Tree Preservation and Protection Guidelines. The status of limbs or trees as deadwood or dead trees must be confirmed by the City's Oak Tree Preservation Consultant.*

[Thousand Oaks, CA: Municipal Code Section 5-14.04]

For the example above, the intended meanings of words such as "cut", "remove", "encroach", "protected zone" and "oak tree", should be defined in the definitions section (see [provision 4](#)). In this example, "cut" includes pruning. Poor pruning practices such as topping (a.k.a. "hatracking") may also be addressed in a separate provision (see [provision 23](#)).

Rather than requiring a permit for pruning, the city of Visalia, CA, requires filing of an "intent to prune notice". The purpose of this provision is to avert improper pruning of oak trees (see also provision 22 - [Help for citizens performing tree maintenance](#)):

*Except in cases of emergencies as described in Section 2344, no person shall prune or cause to be pruned any Oak Tree limb of a diameter of 2" or greater within the City of Visalia without first submitting a completed Oak Tree Intent To Prune Notice with the Director, as provided herein.*

[Visalia, CA: Ordinance Code Section 2345]

**Criteria and standards for approving regulated activities.** The criteria for approving tree removal or damage will vary somewhat between locations, due to the predominant tree species present or other site-specific details. The example below is typical of criteria used in many ordinances.

*The intended decision of the Director shall be based upon reasonable standards, including, but not limited to, the following:*

*(a) The condition of the Oak Tree with respect to its general health, damage, status as a public nuisance, danger of falling, proximity to existing or proposed structures, interface with utility services, and its status as host for [parasitic] plant[s], pest[s], or disease[s] endangering other species of trees or plants with infection or infestations.*

*(b) The necessity of the requested action to allow construction of improvements or otherwise allow economic or other reasonable enjoyment of property.*

*(c) The topography of the land and the effect of the requested action on soil retention, water retention, and diversion or increased flow of surface water*

*(d) The number, species, size and location of existing trees in the area and the effect of the requested action on shade areas, air pollution, historic values, scenic beauty, and the general welfare of the City as a whole. (e) Good forestry practices such as, but not limited to, the number of healthy trees a given parcel of land will support.*

[Visalia, CA: Ordinance Code Section 2342]

In the example above, the permitting authority essentially weighs various tree-related factors, such as tree health and growing conditions, potential hazard, and local environmental impacts, against the needs or desires of the property owner. Unfortunately, this can easily become a contest to see who has more clout - the property owner or the tree. More often than not, the tree loses the contest, largely because the tangible economic interests of the property owner (e.g., potential income, value of property improvements) are pitted against the less tangible and/or poorly quantified community-wide values provided by the tree (e.g., aesthetics, erosion protection, heat island mitigation).

Most heritage or landmark tree provisions set criteria for approving regulated activities such as tree removal, but few actually set minimum performance standards for approval. Although the criteria for approving regulated activities may be similar in many communities, appropriate performance standards will vary between jurisdictions. Standards should take into account factors such as the number and type of trees that are regulated by the ordinance, characteristics of the local community forest, and the amount of community

support for tree protection. The following example sets standards for disallowing tree removal, but the use of terms such as "substantially alter", "reasonable accommodations", and "significant adverse effect" are vague and subject to diverse interpretations. Explicit minimum standards (e.g., "loss of more than 2.5% in property values") would be preferable.

*Removal of trees - Conditions and exceptions*

- (1) *Tree removal shall be disallowed in the following circumstances:*
- (a) *Soil erosion or runoff problems will result due to topography, soil type, or proximity to flood plain or river protection areas; and the removal will substantially alter the existing soils adversely with regard to runoff and erosion. Information submitted by the City Engineer or other environmental specialist may be used by the Arborist in his evaluation.*
  - (b) *Specimen trees are located on site and cannot be adequately protected or replaced. Additionally, removal may be disallowed if reasonable accommodations can be made to alter the proposed project to save specimen trees and have not been made.*
  - (c) *Property degradation -- the removal will have a significant adverse effect on property values of any adjoining property. ...*

(2) *Exceptions. Tree removal from a site may be allowed if:*

- (a) *The tree is located in an area where a structure or improvement will be placed and the tree cannot be relocated on the site because of age, type or size of tree.*
- (b) *The tree is diseased or structurally unsound...*

[Roswell, GA: Municipal code Article XIX, Section 1900.13 ]

Standards do not necessarily have to pose absolute limits on tree removal. They could serve to establish a set of thresholds; as each threshold is exceeded, permit requirements would become more stringent. A tiered system could provide an incentive for landowners to minimize the removal of protected trees. The example below illustrates how such standards might be established and related to the community benefits that trees provide. Minimum standards are explicitly stated in the example.

*Requests for removal of protected trees shall be subject to the additional permit and mitigation requirements listed in Section... if any of the following conditions exist:*

*(1) Tree removal would result in more than a 25 percent reduction of the tree canopy cover on the subject parcel over the most recent three-year period.*

*(2) The ground slope within the drip line of the protected tree exceeds:*

- 15 percent for soils with a soil K value of 0.3 or greater;*
- 20 percent for soils with a soil K value less than 0.3.*

*(3) Tree removal would remove midsummer shade (as defined in Section ...) from more than 700 square feet of pavement or other nonvegetated improved surface.*

[Example text by the authors]

The standards may also be listed in a separate document which is referenced in the ordinance as in the following example.

*Notwithstanding any of the other requirements of these regulations, it shall be unlawful to remove a specimen tree without the express written permission of the County Arborist or authorized agent(s). [The decision of the the County Arborist or authorized agent(s) shall be consistent with the] Administrative standards [that] have been established by the Director of the Department of Environment and Community Development for the identification, preservation and protection of specimen trees.*

[Fulton Co, GA: Tree Preservation Ordinance Sec. I.V.C]

Most individual tree protection provisions are poorly suited to protecting groups or stands of trees because they lack performance standards that adequately account for the cumulative effect of tree loss. Evaluations are normally made on a tree-by-tree basis in individual tree protection provisions. If we look at any single tree closely enough, it is usually possible to find some reason to permit its removal - it may be relatively small, or in less than perfect condition, or located in an inconvenient portion of the parcel. By focusing on each individual tree, a heritage tree provision can allow a landowner or developer to "divide and conquer" a stand of trees, sometimes reducing a functional stand to one or two token heritage trees. Better protection of tree resources in wooded or forested areas can generally be achieved by utilizing strategies discussed under [provision 32](#).

**Permit process requirements.** Permit applicants are normally required to provide the information necessary to decide if the proposed action meets the established standards for approval. Depending upon the criteria used to judge tree removal applications, this may include plot maps, data on tree size and condition, and the anticipated visual or environmental effects of removal. As a general rule, the information required should be limited to that which is needed to determine whether the permit should be granted and what mitigation (if any) should be required to offset the impacts of a permitted action. Many cities have standard forms listing the types of information to be submitted. Some communities exempt their municipal departments from the permit process, although this is not the case in the following example. Requiring city departments to meet the same requirements as private property owners assures more uniform implementation, and may provide beneficial public relations value as well.

*Any person desiring to cut, move or remove a tree or protected tree within the city of Belmont shall apply to the Superintendent for a permit. A permit is not required for pruning as herein defined. The application for the permit shall be made on the form provided by the Superintendent for this purpose and shall include the number, location and type(s) of the tree(s) to be cut, moved or removed and the reason for such action. The applicant may submit an arborist's report or other expert evidence for consideration. The application shall be accompanied by any required fee to cover the cost of processing as set in the current City fee schedule. Fees shall be waived for applications made by a department of the City of Belmont on its own behalf.*

[Belmont, CA: City Code Section 25-5]

While permit fees are normally collected from developers, some communities do not charge fees to homeowners who are required to get permits for pruning or removing private trees. This may help boost voluntary compliance, since homeowners may incur various costs simply to meet requirements for the permit application.

Many provisions that regulate tree removal during development require a report by a qualified professional on the condition of the trees. The professional may either be the city arborist or a qualified outside consultant. Because the applicant typically has a vested interest in removing trees that may conflict with development plans, a clear conflict of interest exists whenever an arborist or other consultant is retained by the applicant. The city or county can essentially eliminate such conflicts of interest by contracting for the services of any outside consultants that may be needed. The consultant is then responsible to and paid by the local government, which in turn recovers the charges from the applicant.

*The permitting authority may also require the applicant to submit a tree condition report prepared by a qualified tree expert selected and retained by the City. The applicant shall reimburse the City for all costs related to the preparation of the report.*

[Example text by the authors]

Some communities also include in this section a requirement that prior to removal, the tree be posted with a notice stating that the tree will be removed within a specified time, and describing the appeals process. Others require public notification before a permit is granted.

*1. Tree Removal Notice Required. Except only as provided in Paragraph 10-11-4F5 of this Chapter, no Person shall cause or undertake any activity that anticipates or involves the actual or reasonably likely Damage or Removal of any Tree on a Lot that has a DBH greater than or equal to 10 inches without first having (a) been issued a valid Tree Removal Notice by the Village Forester pursuant to the requirements of Paragraph 10-11-4F2 and Paragraph 10-11-4F3 of this Chapter, and (b) displayed the Tree Removal Notice pursuant to the requirements of Paragraph 10-11-4F4 of this Chapter.*

*2. Tree Removal Notice Application. Any Person desiring, or required to obtain, a Tree Removal Notice shall submit to the Village Forester a Tree Removal Notice Application on a form provided by the Village.*

*3. Action on Tree Removal Notice Application. Within 72 hours after receipt of a Tree Removal Notice Application, the Village Forester shall approve the Tree Removal Notice Application and issue a Tree Removal Notice if the Village*

*Forester determines that all of the information required by the Tree Removal Notice Application is true and correct. The Village Forester shall not approve or issue a Tree Removal Notice, if the Village Forester determines that the proposed activity constitutes a Regulated Activity. In such event, the regulations of this Chapter applicable to Regulated Activities shall apply in lieu of the regulations of this Subsection 10-11-4F.*

*4. Form and Display of Tree Removal Notice. At least 48 hours immediately prior to undertaking the activity for which a Tree Removal Notice is sought, the Tree Removal Notice shall be posted on the Lot on which the proposed activity is to take place in a manner so as to be clearly and prominently visible from at least one Public Right-of-way abutting such Lot.*

[Lake Bluff, IL: Village Code Section 10-11-4F]

*In the case of removal of any heritage tree...the director shall not act on such an application until a hearing is held thereon. Notice of the time and place of the hearing shall be posted in a conspicuous place on the real property upon which the heritage tree is located and shall be mailed to the applicant and all owners of real property within a five hundred (500) foot radius of the real property upon which the heritage tree is located...*

[Sacramento, CA: City Code Section 45.217]

**Conditions required for approval.** Trees that are nominally "preserved" in the project design process can be lethally damaged during the construction phases of a project. Trees in constructed areas can be seriously damaged by alterations in the rootzone that destroy roots directly (e.g., trenching, lowering of soil grade) or indirectly kill roots by creating adverse soil conditions (e.g., addition of fill soil, soil compaction, impermeable pavement). Many publications have described how trees are damaged in the construction process and techniques for avoiding or minimizing damage through proper planning and construction techniques (e.g., [Coder 1996a,b](#); [Harris et al 1999](#), [Johnson 1999](#), [Matheny and Clark 1998](#), [Schrock 1996](#), [Sydnor, Sydnor and Heiligmann, WFC and Morgan 1989b](#)).

To address this issue, some tree protection ordinances include specifics on how trees are to be protected during construction. However, details of tree protection in construction sites are highly technical and subject to revision and modification based on both local experience and new research. Site-specific tree protection specifications developed by a qualified professional are likely to be more effective than general "cookbook" standards. Hence, it is preferable to set a performance standard for tree protection in the ordinance but to avoid including the actual technical specifications. The provision should authorize the tree program manager to prepare, enforce, evaluate, and revise the actual specifications for tree protection. Although some communities have developed quite extensive tree protection guidelines which are separate from the ordinance itself, even highly detailed guidelines cannot substitute for a case-by-case analysis by a qualified professional.

*...Tree protection shall comply with the guidelines in the Tree Protection Guide for Builders and Developers by the Florida Division of Forestry and any other reasonable requirements deemed appropriate by the Chief to implement this part.*

[Jacksonville, FL:City Ordinance Sec.656.1207a]

Unless a site is carefully monitored throughout the entire construction period, damage inflicted to tree roots may not be apparent. Furthermore, aboveground symptoms related to root damage may not become obvious

for a number of years after the damage is done. Some communities require developers to post performance bonds for trees that are to be retained so that the developer can be held accountable for tree damage that occurs during construction. A relatively long bonding period, preferably 5 years or more, should be used so that the impacts of construction on tree health can be adequately evaluated. The fact that a retained tree is still alive is not an adequate performance standard; performance bonds should not be released if retained trees show any decline in vigor or condition. In order to document changes in tree condition, tree ratings should be made prior to construction and shortly before the end of the bonding period.

*Bonds, as required by this section, shall be in the form of letters of credit, certificates of deposit, cash bond, bonds issued by an insurance company legally doing business in the State of Florida, or other acceptable means agreeable to the city attorney. The letters of credit and certificates of deposit shall be drawn upon banks or savings and loans legally and actually doing business in Florida. Such bonds must meet the approval of the city attorney's office. This bond shall be in addition to any other bond required by any other governmental entity.*

*(1) Bonds shall be required for licenses involving the replacement of ten (10) or more trees, or the relocation of five (5) or more trees, or the relocation of any tree with a DBH of ten (10) inches or greater.*

*(2) Calculation for the amount of bonds shall be computed based upon the equivalent canopy replacement criteria applied to each street to be relocated or replaced, as provided in section 26-20 and upon the cost of installation and maintenance. The fair market value of the cost of trees that would be required to compensate for the canopy to be [relocated] or replaced shall be posted. The bond period shall be for the tree replacement performance period, as stated in the license or as extended or released, plus an additional sixty (60) days. The form of security shall be reviewed by the city attorney's office for legal sufficiency and may not be accepted until approved.*

*(3) Release of bonds:*

*a. Upon successful tree relocation and replacement as determined by this article and written approval by the city bonds required for tree relocation and replacement shall be released. Where possible, bonds shall be partially released for partially successful relocation/replacement projects, with the amount retained equal to the value of the additional replacement trees required, plus installation and maintenance.*

*b. Bonds may be released by the city when fee simple title is transferred. The city may condition the release of the bond upon the establishment of a new bond by the new owner in fee simple.*

*(4) Where the licensee plants fifty (50) percent more than the required number of replacement trees and establishes a suitable maintenance plan to ensure the viability of the replacement trees, the city may recognize the additional replacement trees as suitable security in lieu of a bond.*

[Dania, FL:City Ordinance Sec. 26-25]



**Compensation required for approval.** The highest priority for a heritage tree provision is avoiding or preventing damage to or removal of protected trees. However, adverse impacts cannot be avoided, a local government may permit tree damage or removal under the condition that the applicant mitigates for the loss or damage. Mitigation generally comes down to the four basic options as shown below.

Mitigation method	Location
1. Protect existing trees	A. On-site
	B. Off-site
2. Plant new trees	A. On-site
	B. Off-site

The mitigation may be carried out directly by the applicant as a condition of approval, or the applicant may be required to pay fees to the city or county in lieu of mitigating directly. In-lieu fees normally paid into a special account used for mitigation planting or protection and the local government becomes responsible for carrying out the mitigation. Some communities refer to the use of in-lieu fees or off-site mitigation in general as [tree banking](#).

Mitigation may appear to be a simple process, but as with many things, the devil is in the details. We explore a number of the options and issues in a separate [mitigation page](#). If tree loss associated with urban development or other discretionary projects is substantial, the mitigation techniques used can have far-reaching consequences on the condition and form of the community forest. Hence, the community's long-term [goals](#) for its urban forest should be considered before determining how to structure the mitigation portion of this provision.

In many ordinances, a formula or standard is provided for calculating the amount of compensation that will be required for trees that are removed or injured. If planting of new trees is the mitigation method used, several different standards are commonly used to determine the amount of replanting that may be required. Common replanting standards include:

- ratios based on the number of trees removed (e.g., one or more new trees for each tree removed)
- ratios based on the diameter or cross-sectional area (or basal area) of trees removed (e.g., one inch of replacement tree caliper for each inch of diameter of removed trees)
- planting standards based on overall canopy cover, density, or basal area standards for a given land use category (e.g., a residential zoning has a standard of 35% canopy cover, replacement planting must be sufficient to provide 35% canopy cover for the parcel within 10 years)

In some instances, it may be appropriate to use the value of the removed trees, as calculated from published tree appraisal standards (e.g., [Guide for Plant Appraisal](#)) as the replacement standard.

Typically, replacement plantings are required to be composed of the same species as those removed if native



species are removed. For nonnative protected tree species, replacements must usually be selected from a list of approved species (or be approved by the city or county arborist or urban forester). In general, replacements are required to have the same mature size as the trees that have been removed, although the city/county arborist should have some discretion in this area to ensure that selected trees are compatible with the planting site.

Trunk caliper (diameter) is used as the standard in the following example, and mitigation standards are more stringent for removal of native live oaks.

*(h) Protected trees identified for removal on the site clearing or tree removal permit application shall be replaced with new planted trees, unprotected trees or transplanted trees. Protected live oaks (Quercus virginiana) removed shall be replaced only with live oaks. The total caliper inches of replacement live oaks shall equal the total caliper inches of protected live oaks removed; for other removed protected trees, the total caliper inches of replacement trees shall equal one-third the total caliper inches removed, unless otherwise approved by the Chief. When there is significant loss of mature tree canopy or specimen trees on a particular site, the size [and/or number] of replacement trees may be increased by up to twice the minimum...by the Chief in order to compensate for that loss. If multi-trunked trees are used as replacement trees, then the total caliper of the four largest trunks shall equal the replacement caliper. New palms may be used only to replace protected palms removed. Replacement species used shall be approved by the Chief...*

*(1) New replacement trees shall meet the minimum standards for landscape materials established by [the administrative standards].*

*(2) Existing trees, two inch caliper or greater, which are not protected trees but which are preserved or transplanted, except those trees located in preserve areas, may be utilized to satisfy tree replacement requirements, subject to the conditions stated in ss. 656.1207 and 656.1213(b) and (d).*

[Jacksonville, FL: City Code Section 656.1206]

The following example uses basal area as the replacement standard, and allows for the use of [in-lieu fees](#) if all required trees cannot be planted at the applicant's site.

*(1) All protected trees removed in accordance with 903.8(1)c. through 903.8(1)h. shall be replaced in accordance with the following criteria. The replacement standards shall be listed on the permit...*

*(2) Any tree removed without a permit must be replaced with trees (not necessarily the same species) whose total basal area equals the basal area of the tree removed. All replacement trees shall be...considered required trees as part of a required landscape plan. As many trees as possible will be replaced [on the project site]. The tree(s) must be ... maintained in good health.*

*(3) When replacement of trees [on the project site] is not possible, the equivalent value of the tree as well as projected costs for installation and maintenance will be assessed by the Zoning Administrator and cash received from the property owner will be placed in the City of Myrtle Beach Tree Preservation Account for planting trees on public property.*

*[Myrtle Beach, SC: Municipal Code Section 903.10]*

The example code below lays out a number of options for mitigating tree loss, including the use of [in-lieu fees](#). These options provide the approving authority a high degree of flexibility in selecting appropriate mitigation.

*Prior to any tree removal, the applicant shall demonstrate through a Tree Protection and Replacement Plan, Sensitive Area Mitigation Plan or other plans acceptable to the Administrator that tree replacement will meet the minimum standards of this section.*

*(1) **Replacement Required.** A significant tree to be removed shall be replaced by one new tree in accordance with subsection (5)...*

*(2) **On-Site Replacement.** Replacement trees shall be planted on the site from which significant trees are removed unless the Administrator accepts one or more of the alternatives set forth in subsection (3).*

*(3) **Alternatives to On-Site Replacement:** When on-site replacement cannot be achieved, the Administrator may consider the following alternatives:*

*(a) Off-Site Tree Replacement.*

*(i) The number of replacement trees shall be the same as described in section 20D.80.20-080(1), Replacement Required. Replacement costs (material plus labor) shall be at the applicant's expense.*

*(ii) Allowable sites for receiving off-site replacement plantings*

*(A) City owned properties identified on...[list of maps];*

*(B) Other City or County-owned open space areas, native growth protection areas (NGPA), or river and stream corridors within Redmond City Limits, or lands controlled by the City;*

*(C) Private open space which is permanently protected and maintained, such as a native growth protection area (NGPA).*

*(iii) All trees to be replaced off-site shall meet the replacement standards of this section.*

*(b) Tree Replacement Fee. A fee in lieu of tree replacement may be allowed, subject to approval by the Administrator after careful consideration of all other options. A tree replacement fee shall be required for each replacement tree required but not planted on the application site.*

*(i) The amount of the fee shall be the Tree Base Fee times the number of trees necessary to satisfy the tree replacement requirements of section 20D.80.20-080. The Tree Base Fee shall cover the cost of a tree, installation (labor and equipment), maintenance for two years, and fund administration.*

*(ii) The fee shall be paid to the City prior to the issuance of a Tree Removal Permit.*

*(iii) A separate account shall be established by the City for fees collected. Tree Replacement fee receipts shall be earmarked specifically for this account. Funds withdrawn from this account shall be expended only for the planting of new trees in City owned parks, open spaces or rights-of way.*

*(c) Landscape Restoration. Where appropriate, the Administrator may consider other measures designed to mitigate the loss of trees by restoring all or parts of the forest landscape and its associated benefits. Measures may include, but are not limited to:*

*(i) Creation of wildlife snags from trees which would otherwise be removed;*

*(ii) Replacement of certain ornamental trees with native shrubs and groundcover;*

*(iii) Replacement of hazardous or short-lived trees with healthy new trees more likely to survive;*

*(iv) "Daylighting" and restoration of stream corridors with native vegetation;*

*(v) Protection of non-significant trees to provide for the successional stages of forest development.*

**Monitoring of protected trees and mitigation areas.** A shortcoming that exists in almost every tree protection ordinance that we have reviewed to date is the lack of a long-term monitoring element. In general, after construction is completed or after a short bonding period (usually two years or less), no further follow-up is required for protected trees or new plantings. The city or county may have no further recourse if protected trees or replacements subsequently decline and die as a result of inadequate protection measures during construction, poor maintenance during or after the bonding period, or removal by new owners. Without continuing efforts to monitor protected trees, a community can continue to lose tree canopy over time even though many trees have nominally been protected or replaced.

We have recommended that all tree ordinances contain a provision to require that ordinance performance be assessed regularly (see [provision 13](#)). However, an additional monitoring provision may be necessary as part of the tree protection code to ensure that the applicant can be assigned a fair share of cost of monitoring long-term compliance. In-lieu fees and other permit approval fees should be sufficient to offset long-term monitoring costs. Monitoring methods are described and discussed in [part 3](#).

*INSPECTIONS: The Village Forester shall, on a regular basis, conduct such inspections and surveys as are necessary to monitor the Trees in the Village and to determine the existence, nature, and extent of violations of this Chapter.*

[Lake Bluff, IL: Village Code Section 10-11-15]

## **32. Conservation of forest and woodland resources during development**

**Purpose:** To promote the conservation of functional forests and woodlands during development.

**Key elements:**

- Types of woodland or forest land subject to regulation
- Activities regulated on lands covered with woodlands or forests
- Criteria and standards for approving regulated activities, including mitigation requirements
- Permit process, including requirements, fees, time limits, and appeals
- Monitoring

**Notes:** The purpose of this provision is to establish a process for conserving woodland and forest resources that is invoked when land use is intensified to the degree that a discretionary permit is required. A provision that seeks to conserve functional forest or woodland systems must at minimum include the following features:

- natural stands or groups of trees are given priority over individual specimens;
- activities that fragment the woodland into small units are minimized;
- meaningful standards for tree canopy retention and reforestation are set;
- provisions are made to allow for natural regeneration of woodland/forest species;
- components of forests and woodlands other than trees are taken into consideration.

Relatively few local governments have implemented woodland protection provisions to date, but interest in this approach has been increasing in recent years. Some communities have attempted to use individual tree protection provisions (see [provision 31](#)) to protect woodlands, primarily by lowering the minimum diameter for tree protection. However, these tree protection provisions usually lack the necessary features noted above, and as a result, they often do not provide for satisfactory woodland or forest conservation.

The state of Maryland has one of the most progressive forest protection ordinances, the Maryland Forest Conservation Act (Natural Resources Article Section Title 5, Subtitle 16) passed in 1992. The Act requires local governments with planning and zoning authority to develop a local forest conservation ordinance and program which is at least as stringent as that spelled out in state law. This allows for a certain degree of program alteration to suit the particular needs and desires of a community. Local programs are audited every two years for compliance with the standards and requirements of the state law. Failure to comply results in administration of the local program by the Maryland Department of Natural Resources until such time as deficiencies in the local program are corrected. According to [Galvin et al](#), in the first 5 years after its enactment, the Forest Conservation Act was responsible for 22,508 acres of forest retention and 4,314 acres of reforestation compared with 12,210 acres of forest cleared as a result of development.

**Regulated lands:** There are three basic approaches that can be used in developing woodland conservation ordinances. Ordinances may use one approach or a combination of these approaches to determine what areas should be subject to conservation and reforestation or afforestation standards.

**Existing forest resources.** In the first approach, only lands with existing woodland or forest resources are subject to the ordinance. This approach is most applicable in areas where current forest cover is at or near historical or potential levels. Establishing the resource baseline is a potential source of problems for this approach. Unscrupulous individuals may destroy or alter much of the resource prior to development in an attempt to avoid conservation requirements that would be invoked upon application for a discretionary permit. To encourage good resource stewardship prior to development, historical aerial photos can be used to establish the forest resource baseline.

**Potential forest resources.** In the second approach, regulated lands include all those that have current forest cover as well as those that historically supported forests or woodlands. This approach is especially applicable in areas where current tree cover is well below former levels and the community has the goal of restoring lost or degraded woodlands and forests. In areas where the historic vegetative cover includes both forest and non-forest vegetation cover types, a delineation of potential or historical woodlands and forests should be prepared. A technical assessment of soils, historical records and photos, and local vegetation types should be conducted to establish a base map of areas that did or could support woodland or forest cover. These non-forested areas and areas with existing forest cover would then be subject to reforestation and afforestation standards. This approach allows for conservation of both existing resources and restoration of lost or degraded resources while taking into account the different capabilities of lands to support forest cover. Minimum afforestation standards could vary by area to reflect the differing capabilities of lands to support tree cover. The use of both current forest baseline data and minimum afforestation standards discourages landowners from clearing lands prior to initiating the development process.

**Universal application.** In the third approach, regulations apply to all lands irrespective of current forest cover. In the Maryland Forest Conservation Act, all landowners seeking to intensify land use on nonurbanized lands are responsible for a given level of woodland or forest canopy whether or not their lands are currently forested. This approach is appropriate in areas where forest canopy cover was historically fairly uniform before being cleared due to logging or clearing for agricultural use or urban development. It may also be appropriate in areas with historically low levels of forest cover if the afforestation standards are set at levels that are readily attainable for virtually any parcel. Minimum afforestation standards included in this approach can provide a disincentive to clear land prior to development.

Regardless of the approach used, existing forests and woodlands should generally be subject to higher conservation standards than potential forest land because existing forests generally have much greater ecological value than a newly planted stand. The following examples are provisions that define what is considered to be current or potential forest or woodland. Forest or woodland types of special local concern may be specifically noted in this section.

*This provision shall apply to all lands within the jurisdiction for which approval for a discretionary project is requested and for which any of the following conditions apply:*

*A. All areas with native trees and associated woody vegetation covering 10% or more of the ground surface as of (month/year), as determined from baseline aerial photography dated (date) on file with the Planning Division.*

*B. Areas that formerly supported native trees or other woody vegetation as shown on base maps on file with the Planning Division. Areas designated as former woodlands shall include lands used for agricultural crops or pasture and urbanized areas covered by structures or pavement at the time of the aforementioned baseline aerial photography for the purposes of this ordinance.*

*C. All areas within 100 feet of a perennial or intermittent stream as shown on base maps on file with the Planning Division.*

*The approving authority shall be authorized to determine whether the provisions of this ordinance apply to any portion of a specific parcel. The burden of proof that the provision should not be applied to a specific parcel shall be on the property owner.*

[Example code by the authors]

*(k) Forest. --*

*(1) "Forest" means a biological community dominated by trees and other woody plants covering a land area of 10,000 square feet or greater.*

*(2) "Forest" includes (i) areas that have at least 100 trees per acre with at least 50% of those having a two-inch or greater diameter at 4.5 feet above the ground and larger, and (ii) forest areas that have been cut but not cleared.*

*(3) Forest does not include orchards.*

[Annotated Code of Maryland Sec 5-1601]

**Regulated activities:** Activities regulated through the permit process should include any that could potentially degrade the woodland. This would include activities such as clearing the understory, or altering watercourses.

*Except as provided for herein, no person or corporation shall destroy or significantly alter any forest or woodland through tree damage or removal, clearing, grading, tilling, burning, application of chemicals, or any other means unless they possess a valid Woodland Alteration Permit. No person or corporation shall be granted a permit for subdivision, grading, building, or the construction of any improvement on wooded or forested lands unless they possess a valid Woodland Alteration Permit. Any alteration of wooded or forested lands shall conform to the conditions and specifications of the Woodland Alteration Permit.*

[Example code by the authors]

On tracts of commercial timberland, state forestry regulations may apply and often take precedence over local ordinances. In California, for example, the Forest Practice Act (California Public Resources Code Section 4511 et seq.) may apply to parcels of commercial forest land larger than three acres. As amended, this act does not allow individual counties to adopt rules or regulations that are stricter than those provided for by the act. However, counties may recommend that the State Board of Forestry adopt additional rules and regulations to account for local needs.

The Maryland Forest Conservation Act applies to any public or private subdivision plan or application for a grading or sediment control permit by any person, local government, or State government unit on areas 40,000 square feet or greater. Exceptions to the Act are specified, and include commercial timber harvesting operations and agricultural uses, as long as they satisfy certain requirements spelled out in the exemptions.

**Criteria and standards for approving regulated activities.** Standards for tree retention and reforestation will vary with the type of woodlands or forests involved. Canopy cover and/or stocking rates (trees per unit area) are probably the most widely applicable ways of expressing these standards. In general, any type of development will result in more canopy loss on parcels with high levels of canopy cover than on parcels with low canopy cover. Therefore, it may be desirable to establish standards for canopy retention that vary with the baseline level of canopy. Foresters or other resource professionals familiar with local conditions should be consulted to help establish meaningful and appropriate standards.

The canopy cover baseline can be used to set both retention and reforestation standards. Parcels showing an increase in tree cover beyond the baseline could be allowed greater flexibility when developed. Parcels showing a loss in tree cover could be required to restock the woodland to acceptable levels before development could occur. This strategy helps to provide a strong disincentive for clearing prior to development. Property owners would protect their future options best by maintaining or increasing tree cover on their lands.

In the first example below, viable stands of trees are given priority over individual trees. However, protection for individual trees of special concern could also be obtained through provisions of a landmark tree provision ([provision 31](#)). If properly constructed, tree protection and woodland conservation provisions can complement each other to provide for more complete management of existing tree resources.



*Canopy retention standards. The following table shall be used to determine the minimum amounts of woodland canopy that must be retained during development on wooded lands:*

*Canopy retention standard shall be the greater of Column A or Column B:*

<i>Baseline canopy cover</i>	<i>Column A</i>	<i>Column B</i>
<i>80-100%</i>	<i>.75 x baseline canopy cover</i>	<i>65% canopy cover</i>
<i>60-79%</i>	<i>.80 x baseline canopy cover</i>	<i>51% canopy cover</i>
<i>40-59%</i>	<i>.85 x baseline canopy cover</i>	<i>36% canopy cover</i>
<i>20-39%</i>	<i>.90 x baseline canopy cover</i>	<i>19% canopy cover</i>
<i>19% or less</i>	<i>1.0 x baseline canopy cover</i>	<i>--</i>

*Example: For 50% baseline canopy, the minimum allowable canopy after development would be the greater of Column A, (.85 x 50% = 42.5% canopy) or Column B, (36% canopy). In this case the minimum allowable canopy after development would be 42.5%.*

*Retention standards shall be applied to retain stands of trees and undisturbed woodlands in priority over individual specimen trees which will be incorporated into the development. No more than 10% of the canopy retention standard may be met by individual trees not included within designated woodlands.*

***Reforestation standards.*** *In areas where tree removal, clearing, fire, or any other intentional or accidental canopy reduction has resulted in canopy levels below the baseline level, the standard for reforestation shall be set at 100% of baseline levels, except that no reforestation standard shall exceed 85% nor be less than 15% canopy cover.*

[Example code by the authors]

In the preceding example, two standards (Columns A and B) are used to provide a smooth transition between the required retention levels. For example, the top baseline canopy class (80-100% canopy) requires 75% retention of existing canopy, the second baseline canopy class (60-79% canopy) has a slightly higher retention standard of 80%. With these ranges, a potential problem arises when the low end of one canopy class is compared to the high end of the adjacent class. The retention standard according to Column A for 80% baseline canopy is 60% canopy cover (.75 x 80%), but the standard for 79% baseline canopy (the next lower class) would be greater at 63% canopy cover (.8 x 79%). When Column B is used, this inconsistency doesn't arise and the percent canopy cover retained steps down as you drop in baseline canopy cover between classes (80% baseline = 65% canopy cover retained, 79% baseline = 63% canopy cover retained).

The Maryland Forest Conservation Act and local ordinances based on it establish standards for both retention of existing forests and for the afforestation or reforestation of lands in connection with development and certain other land use changes. For both situations, canopy cover standards vary by the land use classification



rather than preexisting levels of canopy cover. The example code below establishes forest conservation thresholds by land use category. If tree removal exceeds the set threshold levels, more stringent mitigation requirements apply. This serves to provide an incentive to project planners to conserve canopy cover to at least the threshold level.

*A. There is a forest conservation threshold established for all land use categories, as provided in Subsection B... The forest conservation threshold [is] the percentage of the net tract area at which the reforestation requirement changes from a ratio of 1/4 acre planted for each acre removed above the threshold to a ratio of 2 acres planted for each acre removed below the threshold.*

*B. After reasonable efforts to minimize cutting or clearing of trees and other woody plants have been exhausted in the development of a subdivision or project plan...the forest conservation plan shall provide for reforestation, purchase of credits from a forest mitigation bank, or payment into the forest conservation fund according to ... the following forest conservation thresholds for the applicable land use category:*

Category of Use	Threshold Percentage
<i>(1) Agricultural and resource areas</i>	<i>50 percent;</i>
<i>(2) Medium density residential areas</i>	<i>25 percent;</i>
<i>(3) Institutional development areas</i>	<i>20 percent;</i>
<i>(4) High density residential areas</i>	<i>20 percent;</i>
<i>(5) Mixed use and planned unit development areas</i>	<i>15 percent;</i>
<i>(6) Commercial and industrial use areas</i>	<i>15 percent.</i>

[Annotated Code of Maryland 08.19.03.01 Article VIII. Sec. 8.1]

Under this system, a parcel being developed for commercial use with 100% forest cover could remove 85% of the existing canopy cover (15% canopy cover remaining) and would remain above the threshold. In contrast, a parcel with only 20% forest cover could remove no more than one quarter of the existing cover to remain above the threshold of 15% canopy cover. Reforestation requirements would apply to both parcels. In this hypothetical example, if we assume both parcels to be 100 acres, the reforestation requirement would be 21.25 acres for the fully canopied site (1/4 x 85 acres of forest removed) compared to 1.25 acres for the site with 20% forest cover (1/4 x 5 acres of forest removed).

If areas with high levels of canopy cover or other sensitive resource areas are to be protected adequately, additional restrictions or modifications of the threshold limits may be imposed in certain areas. In the example below, different woodland or forest clearing threshold values apply in "limited development areas" and "resource conservation areas".

*...c) For the alteration of forest and developed woodland in limited development areas and resource conservation areas, the following criteria shall be met:*

- (1) (i) Up to 20% of any forest or developed woodland may be cleared for development provided it is replaced on at least an equal area basis;*
- (ii) an additional 10% up to a total of 30% of the forest or developed woodland may be cleared if approved by the Office of Planning and Zoning, and if it is replaced, by at least one and one-half times the total area of disturbed forest or developed woodland;*
- (iii) all remaining forest or developed woodland shall be maintained through restrictive covenants or similar instruments that are recorded in the land records of Anne Arundel County; and*
- (iv) when an area for reforestation is not available on the site, the developer shall either select an alternative off-site location or shall pay a fee as provided in subsection (d) of this section;*

*...*

*(3) if there is no established forest on a development site, the site shall be planted to provide a forest or developed woodland cover of at least 15%;*

*(4) replanted or afforested areas shall be maintained as forest cover through easements, restrictive covenants, or similar protective instruments; ...*

[Anne Arundel County, MD; Ord 66-99 section 2-314.]

On a more local scale, higher retention or reforestation standards may be applied to sensitive areas or critical resource areas within a parcel. Areas such as floodplains, streams and associated buffer areas, steep slopes or other highly erodible areas, and critical wildlife habitats may be slated for higher levels of protection than is provided for other forested areas.

*(c) Priority for retention and protection.- The following trees, shrubs, plants, and specific areas shall be considered priority for retention and protection, and they shall be left in an undisturbed condition unless the applicant has demonstrated, to the satisfaction of the State or local authority that reasonable efforts have been made to protect them and the plan cannot reasonably be altered:*

- (1) Trees, shrubs, and plants located in sensitive areas including 100-year floodplains, intermittent and perennial streams and their buffers, coastal bays and their buffers, steep slopes, and critical habitats;*
- (2) contiguous forest that connects the largest undeveloped or most vegetated tracts of land within and adjacent to the site,*
- (3) Trees, shrubs, or plants identified on the list of rare, threatened, and endangered species of the U.S. Fish and Wildlife Service or the Department;*
- (4) Trees that are part of a historic site or associated with a historic structure or designated by the Department or local authority as a national, state, or local Champion Tree; and*
- (5) Trees having a diameter measured at 4.5 ft above the ground of*

- (i) 30 inches; or*
- (ii) 75% of the diameter, measured 4.5 ft above the ground, of the current State Champion Tree of the species as designated by the department.*

[Annotated Code of Maryland Sec 5-1607]

**Afforestation standards** are set by the Maryland Forest Conservation Act and local ordinances based on it. Parcels that have less than the set minimum amount forest cover must be afforested to minimum levels if they are developed. Landowners that plan to develop in the future have an incentive to establish tree canopy on portions of their property that would not be affected by a future development. Section (d) in the example below provides an additional disincentive for "preemptive" clearing.

*(a) The amount of afforestation required under this subtitle shall be determined according to the amount of existing forest cover as provided in this section.*

*(b) A site that has less than 20% of its net tract area in existing forest cover shall be afforested up to at least 20% of the net tract area for:*

- (1) agricultural or resource uses; and*
- (2) medium density residential uses.*

*(c) A site that has less than 15% of its net tract area in existing forest cover shall be afforested up to at least 15% of the net tract area for:*

- (1) institutional development uses;*
- (2) high density residential uses;*
- (3) mixed use or planned unit development uses; and*
- (4) commercial or industrial uses.*

*(d) If existing forest cover is cut or cleared on a site that is below the afforestation levels set forth in this section, the site shall be reforested at a ratio of two acres planted for every acre cut or cleared, and this reforestation shall be in addition to the afforestation required by this section.*

[Anne Arundel county, MD; Ord 66-99 section 2-304.6]

In the example below, standards for approving regulated activities include provisions related to stand regeneration. Such standards may be necessary in areas where native tree species are not regenerating well under current stand management conditions.

*Removal of oak trees in the areas outside of the North County Area Plan, ... shall be allowed only if the following purposes and standards are satisfied...*

*B. Standards:*

*1. The current Best Management Practices as promulgated by the University of California... shall be followed to maintain and promote regeneration of oak trees.*

*2. A representative sample of sizes, ages and species of oaks shall be retained with special emphasis placed on retaining saplings.*

....

[Monterey County, CA: Code Section 16.60.050B]

**Permit process requirements, conditions and mitigation required.** Permit applicants are normally required to provide the information necessary to decide if the proposed action meets the established standards for approval. This section should clearly indicate the general classes of information to be submitted with the permit application. The community forester or approving authority should be authorized to prescribe the specifics of the type and format of required information. Types of information that might be requested include baseline information on the status of the resource before development, and information on the proposed changes and their expected impacts. This should include data on all components of the woodland, including tree resources, understory vegetation, wildlife, soils, and hydrology.

As noted in [provision 31](#), consultants retained by the applicant have a de facto conflict of interest because the applicant typically has a vested interest in removing trees or otherwise minimizing requirements associated with resource protection. The city or county can eliminate the conflict of interest by directly contracting for the services of any outside consultants that may be needed. The consultant is then responsible to and paid by the local government, which in turn recovers the charges from the applicant.

Whenever development occurs around sensitive natural resources, the primary goal should be to avoid adverse impacts through a sensitive development plan. To promote woodland conservation, the plan should strive to maintain groups of trees in contiguous areas that function as a cohesive habitat. Development patterns that cluster development on a portion of the overall project area and leave wooded areas as dedicated open space provide one means for maintaining functional woodlands.

Compensatory mitigation should only be considered after all reasonable efforts have been made to minimize loss. Reforestation on- or off-site is one form of compensation, but a newly-planted forest or woodland does not have the same habitat value or ecological diversity found in a mature stand. Although reforestation should be promoted for long-term resource conservation, suitable mitigation of short-term impacts can best be obtained by requiring that equivalent quantities of developable land be reserved from development. Such woodland reserves should remain undeveloped at least until reforested areas attain the resource and habitat value of woodlands which were lost. It may be desirable to target certain critical areas for acquisition as permanent forest/woodland reserves through this process of "mitigation banking" (see also [Mitigation](#) and [Tree banking](#)).

*1. Removal of more than three protected trees on a lot in a one year shall require a Forest Management Plan and approval of a Use Permit by the Monterey County Planning Commission.*

*2. The Forest Management Plan shall be prepared by a qualified professional forester, as selected from the county's list of Consulting Foresters. Plan preparation shall be at the applicant's expense.*

*The Director of Planning and Building Inspection shall prescribe the format and content requirements for the Forest Management Plan and maintain a list of qualified and acceptable foresters to prepare the Forest Management Plan.*

[Monterey County, CA: Code Section 16.60.040C]

***Requirements for approving Woodland Alteration Permits.*** Issuance of a Woodland Alteration Permit is contingent upon the following requirements:

*1. A Woodland Conservation Plan for the subject property must be approved by the approving authority.*

*2. The level of canopy removal requested must not exceed that provided for in the Canopy Retention Standards.*

*3. All reforestation plantings required as a condition of approval must be installed at least one year prior to the issuance of the Woodland Alteration Permit, and must be approved as adequate after inspection by the approving authority.*

*4. All other requirements pursuant to county ordinances, the California Environmental Quality Act (CEQA), and other applicable local, state, and federal laws and regulations must be fulfilled.*

[Example code by the authors]

**Woodland Conservation Plan.** *The purpose of the Woodland Conservation Plan (WCP) is to establish specific methods to conserve existing and potential woodland resources during development. The WCP shall be prepared by a qualified natural resources consultant retained by the county, and the charges of preparing the WCP shall be borne by the applicant.*

*The WCP shall provide that a project meets the Retention and Reforestation Standards of this provision through any, or a combination, of the following methods or other methods acceptable to the approving authority.*

*1. Minimizing the extent of the development and siting it to avoid impacts on existing woodlands.*

*2. Clustering development on a portion of the project area to retain continuous stands of trees in the nondeveloped portion. Transfers of development density from nondeveloped portions of the project area may be allowed only if nondeveloped portions meet the criteria for developable land.*

*3. Providing for reforestation of equivalent sites within or outside of the project area that will not be subject to future development. Where reforestation is used to replace existing woodlands removed for development, estimated canopy cover 20 years after planting shall be used to calculate the equivalent canopy cover provided.*

*4. Public acquisition of title to or permanent conservation easements on developable lands with equivalent woodland resources located outside of the project area. Total area, canopy cover, woodland type, understory vegetation, wildlife habitat value, and other appropriate resource assessment criteria shall be considered in determining whether off-site resources are equivalent to those of the project site.*

*Methods that protect and enhance existing woodlands shall be given precedence over those that restore non-wooded lands. Protection of woodlands within the project area shall be given precedence over off-site acquisition. The location of off-site mitigation areas is subject to the approval of the approving authority.*

[Example code by the authors]

As noted under [provision 31](#) and discussed in the [mitigation page](#), ordinances may provide that fees be paid to a special fund that is directly used to pay for woodland/forest restoration. This is the case for the Maryland Forest Conservation Act and local ordinances based on it, as shown in the example below. The provision provides for a fee that is based on the area of plantings that are required as mitigation. The Act provides a time limit for the Department (or local governments) to accomplish the reforestation and afforestation activities that the in-lieu fees are collected to fund. A specific time limit may provide a strong incentive to ensure that the responsible agency actually accomplishes mitigation projects. However, setting an arbitrarily short time limit could be counterproductive if it limits the time available to complete complicated land acquisitions, or forces reforestation to occur during unfavorable conditions (e.g., an extended drought). A flexible time limit may be needed to ensure that funds are spent efficiently. Note in the example below that the use of funds returned to

the payer remain restricted, and can only be used for local tree planting projects.

*(b) Contribution; rate. - ...if any person subject to this subtitle demonstrates to the satisfaction of the appropriated State of local authority that the requirements for reforestation or afforestation on-site or off-site cannot be reasonably accomplished, the person shall contribute money at a rate of 10 cents per square foot of the area of required planting to the Forest Conservation Fund.*

*... (d) Time period for reforestation or afforestation; return of funds. - (1) The Department shall accomplish the reforestation or afforestation for which the money is deposited within 2 years or 3 growing seasons, as appropriate, after the receipt of the money.*

*(2) Money deposited in the Forest Conservation Fund under subsection (b) of this section shall remain in the fund for a period of 2 years or 3 growing seasons, and at the end of that time period, any portion that has not been used to meet the afforestation or reforestation requirements shall be returned to the person who provided the money to be used for documented tree planting in the same county or watershed beyond that required by this subtitle or other applicable statutes.*

*(e) Management of Fund. - (1) Money deposited in the Fund under subsection (b) of this section may only be spent on reforestation and afforestation, including site identification, acquisition, and preparation and may not revert to the General Fund of the State.*

[Annotated Code of Maryland Sec 5-1610]

Ordinances modeled on the Maryland Forest Conservation Act require that a **forest stand delineation** and a **forest conservation plan** be prepared prior to any approval of forest removal..

*(a) A forest stand delineation shall be prepared by a licensed forester, licensed landscape architect, or qualified professional who meets the requirements stated in COMAR, § 08.19.06.01B.*

*(b) Each forest stand delineation shall:*

*(1) consist of a map and a narrative;*

*(2) be used to determine the most suitable and practical areas for forest conservation; and*

*(3) contain or be accompanied by:*

*(i) a topography map delineating intermittent and perennial streams, and steep slopes over 25%;*

*(ii) soil mapping units and narrative indicating soils with structural limitations, hydric soils, or soils with a soil K value greater than 0.35 on slopes of 15% or more;*

*(iii) forest stand data indicating species, location, and size of trees and showing dominant and CO-dominant forest types;*

*(iv) location of 100-year floodplains;*

*(v) information required by the Forest Conservation Technical Manual; and*

*(vi) any other information required by the Department to assist in its review. ...*

[Anne Arundel County, MD; Ord 66-99 section 2-304.2]

*(a) A forest conservation plan shall be prepared by a licensed forester, a licensed landscape architect, or a qualified professional who meets the requirements stated in COMAR, § 08.19.06.01B.*

*(b) (1) A forest conservation plan shall:*

*(i) give priority to retention of existing forest on the site; and*

*(ii) if there is an insufficient amount of existing forest on the site, provide for afforestation as provided in § 2-304.6 of this subtitle.*

*(2) If retention of existing forest at or above the forest conservation threshold established in § 2-304.5 of this subtitle is unfeasible, a subdivider shall demonstrate:*

*(i) that there are no available methods or techniques to implement forest retention at the forest conservation threshold;*

*(ii) why priority forests and priority areas, as determined by an evaluation of the forest stand delineation, cannot be retained; and*

*(iii) where afforestation and reforestation will occur, with preference given to replanting in the priority areas.*

*(3) If a subdivider demonstrates to the satisfaction of the Department that retention of existing forest is unfeasible, the forest conservation plan shall provide for:*

*(i) reforestation in accordance with the provisions of §§ 2-304.4 and 2-304.5 of this subtitle; and*

*(ii) afforestation in accordance with the provisions of §§ 2-304.4 and 2-304.6 of this subtitle....*

[Anne Arundel County, MD; Ord 66-99 section 2-304.3]

Invoking state regulations may provide another possible avenue for addressing woodland or forest protection. In California, for example, the local government can trigger the review and mitigation requirements of the California Environmental Quality Act (CEQA) when a project will have a significant impact on sensitive and important natural resources such as woodlands. It may be useful to include provisions that clearly indicate under what circumstances an Environmental Impact Report (EIR) is required. This may require two steps. First, the provision should state under what circumstances tree removal or woodland alteration will be considered a "project" under CEQA and thus subject to review. Second, the provision can set specific thresholds for loss or disturbance of woodlands and forests that would be considered "significant" under CEQA, and therefore require the preparation of an EIR. Requiring the preparation of an EIR above a certain threshold may help dissuade applicants from automatically requesting the maximum amount of clearing provided for in the retention standards.



*All tree removal requests coming under this subsection shall be subject to the requirements of the California Environmental Quality Act (CEQA).*

[Monterey County Code Section 16.60.040C]

***CEQA compliance.*** *The proposed removal or disturbance of woodlands to the maximum extent allowed under the Retention Standards shall require the preparation of an Environmental Impact Report (EIR). Based upon the specific characteristics of the site under consideration, the approving authority may also determine that lesser amounts of woodland removal or alteration pose a significant adverse impact and require the preparation of an EIR.*

[Example code by the authors]

**Monitoring.** Monitoring of ordinance effectiveness, the success of required mitigation, and the ongoing status of the resource are especially critical for woodland and forest conservation ordinances. Example monitoring provisions are discussed under [provision 13](#).

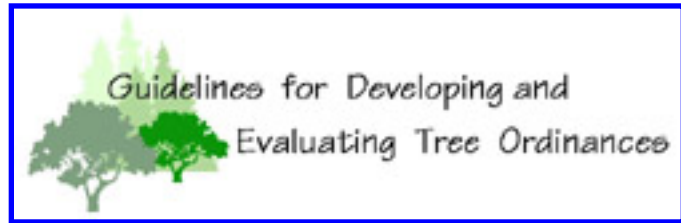

## View or solar access ordinance provisions (Provisions 33-37)

The provisions on this page can be used as a guide for drafting an ordinance to facilitate the [resolution of conflicts between citizens that pertain to trees on private property](#). The provisions covering this goal may be included in the tree ordinance or enacted as a separate ordinance. If tree dispute resolution provisions are included within the tree ordinance, it will be necessary to include appropriate references in provisions [3](#), [4](#), [10](#), [11](#), and [15](#). If a separate tree dispute ordinance is developed, these provisions will need to be included in the ordinance.

<b>Number</b>	<b>Provision</b>	<b>Goals</b>
16	<a href="#">Establish a tree board or commission</a>	6,8
17	<a href="#">Specify cooperation between departments and agencies</a>	6,7
18	<a href="#">Develop a comprehensive management plan</a>	1,2,3,4,5,7
19	<a href="#">Resolution of conflicts between trees and structures</a>	1,2,4
20	<a href="#">Exemption from Solar Shade Control Act (California)</a>	1
21	<a href="#">Responsibilities of property owners</a>	5
22	<a href="#">Help for citizens performing tree maintenance</a>	2,8
23	<a href="#">Topping prohibited</a>	2
24	<a href="#">Permit required for planting trees in the public right-of-way</a>	5
25	<a href="#">Planting requirements</a>	1,2,3,4,5
26	<a href="#">Situations which are declared to be public nuisances</a>	2
27	<a href="#">Abatement of hazards and public nuisances</a>	2
28	<a href="#">Licensing of private tree care firms</a>	2
29	<a href="#">Harming public trees forbidden</a>	2
30	<a href="#">Permit required for activities that may damage city owned trees</a>	1,2,4,5
31	<a href="#">Permit required for activities that may damage protected private trees</a>	1,2,4
32	<a href="#">Conservation of forest and woodland resources during development</a>	1,3,4
33	<a href="#">Procedures to be followed in resolving tree disputes</a>	9

34	<a href="#">Standards for resolution of tree disputes</a>	9
35	<a href="#">Apportionment of tree dispute resolution costs</a>	9
36	<a href="#">Recording for notification of future owners</a>	9
37	<a href="#">Enforcement of tree dispute resolutions</a>	9

### 33. Procedures to be followed in resolving tree disputes

**Purpose:** To set forth procedures to be followed in resolving disputes over alleged obstruction of views or sunlight by trees.

**Key elements:**

- -Procedure for notifying the tree owner of the complaint
- -Procedure for resolving the claim
- -Position(s) responsible for hearing claims

**Notes:** When the tree owner is a private individual, the procedure for resolving the complaint usually involves a series of steps. The procedure is initiated by notifying the tree owner of the complaint in writing. The complaining party and the tree owner may then attempt to resolve the conflict informally in face-to-face meetings or through the use of a mediator. If this is unsuccessful, a formal procedure for mediating the dispute is initiated.

Some jurisdictions require a public hearing before a city committee in the event that private reconciliation or mediation fails to resolve the dispute. In this case, the findings of the committee may be subject to appeal. In other jurisdictions, binding arbitration is an option. No appeals are allowed if binding arbitration is elected.

Responsibility for hearing disputes should be designated. If a committee, such as a community tree board already exists, this could be one of its responsibilities. If a new committee needs to be constituted to settle disputes, its makeup should be specified in the provision.

*A claimant who believes in good faith that the growth, maintenance or location of trees situated on the property of another diminishes the beneficial use, or economic value of his or her property because the tree interferes with the access to sunlight or views naturally accruing to the property, shall notify the tree owner in writing of these concerns. The notification should, if possible, be accompanied by personal discussions to enable the complaining party and tree owner to attempt to reach a mutually agreeable solution.*

[San Francisco, CA: Public Works Code Section 823(a)]

*A. Where the initial reconciliation attempt fails, the claimant shall propose mediation as a means to settle the dispute on a relatively informal basis. Acceptance of mediation by the tree owner shall be voluntary. If mediation is elected, the parties shall mutually agree upon a tree mediator. ... The tree mediator shall not have the power to issue binding orders for restorative action, but shall strive to enable the parties to resolve their dispute at this stage by written agreement in order to eliminate the need for a hearing before the Tree Commission or for litigation.*

*B. Where the initial reconciliation process fails and where mediation has not resolved the dispute, the claimant and the tree owner shall be subject to the findings and order of the commission following a noticed hearing...*

[El Cerrito, CA: City Code Section 10.50.150]

When the city is the owner of the tree in dispute, a more streamlined procedure can be used. This procedure essentially calls for assessment of the validity of the claim in light of the standards in provision 34.

*A claimant who believes in good faith that the growth, maintenance or location of trees situated on City property diminishes the beneficial use, economic value, sunlight, or the enjoyment of views naturally accruing to the claimant's property, may apply to the City on a form approved by the Public Works Director....All view claims found by the City to be valid shall be subject to restorative action...*

[Sausalito, CA: City Code Section 11.12.040D]

## **34. Standards for resolution of tree disputes**

**Purpose:** To establish standards to judge tree dispute claims.

**Key elements:**

- -Documentation to be submitted by the complaining party
- -Standards for evaluating views
- -Standards for assessing the degree of view obstruction
- -Standards for judging the positive and negative aspects of corrective action
- -Considerations for selecting restorative action

**Notes:** The complaining party is generally required to demonstrate that view obstruction did not exist at the time they acquired the property. The claimant is also required to demonstrate that the burdens imposed by the tree outweigh the benefits that the tree provides.

To minimize the negative impacts on the trees involved, some ordinances specify a hierarchy of potential

corrective actions. Tree removal and topping should be discouraged, and less drastic steps should be used whenever possible.

*In adjudicating all disputes, unless otherwise specifically provided, the provisions of this chapter are to be utilized to resolve view claim disputes.*

*A. The claimant has no right greater than that which existed at the time of the claimant's acquisition of the property involved in the view claim and shall provide evidence to prove the extent of that original view and right.*

*B. The character of a view shall be determined by evaluating:*

- 1. The vantage point from which the view is obtained;*
- 2. The existence of landmarks or other unique features in the view;  
and*
- 3. The extent to which the view is diminished by factors other than the tree(s) involved in the claim...*

*C. The existence and character of the view obstruction shall be determined by evaluating:*

*1. The extent of the alleged view obstruction, expressed as a percentage of the total view, and calculated by means of a surveyor's transit or by photography or both; and*

*2. The extent to which landmarks or other unique features in the view are obstructed.*

[El Cerrito, CA: City Code Section 10.20.130]

*In resolving the tree dispute, the tree arbitrator or court shall consider the benefits and burdens derived from the alleged obstruction within the framework of the purposes of this Article as set forth in Section 821 in determining what restorative actions, if any, are appropriate. In proposing any given restorative action the complaining party shall have the burden of proving that the burdens posed by the tree owner's trees outweigh the benefits provided by the trees with respect to the proposed restorative action.*

*(a) Burdens.*

- (1) The hazard posed by a tree to persons or structures on the property of the complaining party including, but not limited to, fire danger and the danger of falling limbs or trees.*
- (2) The extent to which the tree diminishes the amount of sunlight available to the garden or home of the complaining party.*
- (3) The extent to which the tree interferes with efficient operation of a complaining party's pre-existing solar energy system...*

*(b) Benefits.*

- *(1) Visual quality of the tree, including but not limited to, species characteristics, size, growth, form, and vigor.*
- *(2) Location with respect to overall appearance, design, and/or use of the tree owner's property.*
- *(3) Soil stability provided by the tree considering soil structure, degree of slope, and extent of the tree's root system...*

[San Francisco, CA: Public Works Code Section 824]

*Any restorative action shall be evaluated based on the standards of this article and consideration of the following:*

- *(1) The effectiveness of the restorative action in reducing the view obstruction....*

[Contra Costa County, CA: Code Section 816-2.612]

*All restorative actions shall be undertaken subject to the following:*

- *1. Restorative actions must be consistent with all applicable statutes, ordinances and regulations.*
- *2. Where possible, restorative actions shall be limited to the trimming and/or thinning of branches; but, when such is not a feasible solution, windowing is the preferable solution...*

[El Cerrito, CA: City Ordinance Section 10.50.130G]

## **35. Apportionment of tree dispute resolution costs**

**Purpose:** To establish a method for assigning costs associated with the dispute resolution process and restorative actions.

**Notes:** The method by which costs are assigned should be specified for both private party disputes and private party-city disputes. Generally, the claimant is assigned the greater share of the associated costs, and may bear all costs if the claim is rejected.

*... The costs of all mandated restorative actions and/or replacement plantings shall be apportioned between the claimant and the tree owner as mutually agreed to, or in the absence of agreement as follows: ...*

[El Cerrito, CA: City Code Section 10.50.150C(2)]

*(a) The complaining party and the tree owner shall each pay 50 percent of the costs of the arbitrator's personal fee, if any.*

*(b) The complaining party shall pay 100 percent of both parties' reasonable attorneys' fees in the event that his or her claim is finally denied, or no action is ordered pursuant to Section 824(c). In all other cases the complaining party and the tree owner shall each pay his or her attorney's fees. Court costs shall be allocated to the parties at the court's discretion.*

[San Francisco, CA: Public Works Code Section 825]

## **36. Recording for notification of future owners**

**Purpose:** To provide notice to future property owners of limitations on the property associated with a tree dispute resolution.

*Any final decision of the tree commission or the City Council, in the case of an appeal, which provides for limitations on the property of a tree owner shall be recorded so that record notice of the decision is given to successors in interest of the tree owner's property.*

[El Cerrito, CA: City Code Section 10.50.202]

## **37. Enforcement of tree dispute resolutions**

**Purpose:** To describe methods for enforcing the tree dispute resolution process. Key elements:

- -Legal classification of violations
- -Descriptions of available enforcement options

**Notes:** The local government may choose to enforce the tree resolution process through its police power, or it may establish the process as "self-enforcing". In the latter case, enforcement is normally provided through civil legal action initiated by the complaining party.

*Violations of this chapter are not misdemeanors or infractions. Enforcement of this chapter shall be by the involved private parties. Any claimant may seek to enforce any restorative action mandated pursuant to this chapter through ordinary legal proceedings.*

[Contra Costa County Code Section 816-2.1004]

*Failure or refusal of any person to comply with a final decision under this Chapter or to comply with any provision of this Chapter shall constitute a misdemeanor and shall be punishable by a fine of \$1,000 or six months in County Jail, or both. Failure or refusal of any person to comply with a final decision under this Chapter shall further constitute a public nuisance which may be abated in accordance with the procedure contained in Chapter 8.24 of the Title...*

[Rolling Hills, CA: City Code Section 8.32.070]





## Part 3. Evaluating the urban forest and ordinance performance

---

As we discussed in [Developing a Community Forest Management Strategy](#), two stages in the urban forest planning process require the use of evaluation methods. To answer the questions "[What do you have?](#)" and "[Are you getting what you want?](#)", you will need to evaluate tree resources, management activities, and public attitudes. Thus, evaluation methods are important tools for formulating and monitoring tree management strategies. In these pages, we discuss how various methods and techniques can be used to evaluate tree resources and community forest management.

You can access our descriptions and examples of urban forest evaluation methods either from the list below or by following the links from the page on [Goals for Community Forest Programs](#). Included in this section are methods for evaluating tree resources, urban forestry management activities, and public attitudes. Most of the techniques summarized here are well established, although a few new applications and adaptations for urban forestry are included. Where possible, we have provided examples to demonstrate actual applications of the techniques described. Please [contact us](#) if you know of other useful links or would like to see additional methods covered.

The key to successful and efficient evaluation lies in focusing on what needs to be evaluated. It is generally not desirable to collect more detailed information than is likely to be used, since cost and effort generally increase with the level of detail. On the other hand, it may be more efficient to collect a variety of data in a single evaluation than to conduct a series of separate evaluations. By following the process described under [Developing a Community Forest Management Strategy](#) you should be able to determine what types of data you will need to collect to meet your needs for information.

### Methods for evaluating tree ordinances and the urban forest ecosystem

\* [Sampling from populations](#). In many cases, it will be more efficient to evaluate a sample of the population under study (trees, parking lots, homeowners) than to evaluate the entire population. Here we discuss how to develop a valid sampling scheme.

\* [Photogrammetry and remote sensing techniques](#). Using stock aerial photographs or other aerial imagery, photogrammetric techniques can be used to assess tree canopy cover quickly and cost-effectively. We discuss the uses of photogrammetry and provide some examples of applications to ordinance evaluation.

\* [Ground survey](#). For many applications, the ground survey is still the simplest and most accurate

means for collecting detailed data on the urban forest. We describe basic ground survey methods and a number of typical applications.

\* [Photo points](#). Photographs taken from the ground or the air can provide graphic and obvious evidence of changes in tree condition and cover. We discuss some considerations for establishing effective, repeatable photo points.

\* [Record keeping and analysis](#). Well-maintained records and databases can be analyzed to provide a wealth of information on ordinance performance. We discuss the use of GIS, tree inventories, and other records.

\* [Public polling](#). People are an integral part of the urban forest ecosystem. We present a brief overview of methods used to assess the opinions of the proverbial person on the street.



## Sampling from populations

---

Many of the evaluation techniques we describe involve collecting information from or about discrete units, such as trees, streets, blocks, or residents. In many cases, it may not be practical to perform a complete census of every unit in the overall population. However, it is still possible to obtain reliable information about the overall population by collecting data from a representative subset or sample. Sampling is simply the technique used to choose representative units for study from a larger population. Sampling is a prerequisite of several of the assessment methods discussed in section 3, including [photogrammetry](#), [ground survey](#), and [public polling](#).

### Statistical bias

The reason for using statistically sound sampling methods is to avoid **bias** in the estimates of the parameter(s) you are measuring. Although the value of any single estimate (biased or not) is unlikely to equal the true population value, the mean of a large number of unbiased estimates will approximate the true value. In contrast, the mean of a large number of biased estimates will either be higher or lower than the true population value, depending on the direction of the bias. Hence, if you are interested in knowing the actual value of a parameter from the population (e.g., actual percent tree canopy cover), you generally want to use an unbiased estimator of that parameter. In some situations, a small bias (e.g., a tendency to slightly over- or underestimate cover) can be tolerated if the bias is small relative to the standard deviation of the estimation errors (perhaps 10% to 15% or less).

Bias in estimates can come from various sources. For instance, if tree shadows are counted as canopy in aerial photo interpretation (misclassification bias), the canopy cover estimate will be biased upward. In public polling, people who fail to respond to a survey may constitute a source of sampling bias. If some segment(s) of the population (e.g., retirees, working couples, low-income households) are either more or less likely to respond than other population segments, responses may not be representative of the population as a whole. Many types of bias can be avoided through good sampling design and the careful implementation of appropriate evaluation techniques.

### Random sampling and random numbers

Most statistical methods are based on the assumption of **random sampling**. This simply means that every unit in the population has an equal chance of being chosen for the sample. Furthermore, the selection of random units should be **independent** of other units that have been sampled. If you reject a sample unit because you think it is too close to one already chosen, your sample will not be random and independent. A relatively simple and reliable method for randomization is to use random numbers. Most spreadsheet, database, and statistical programs that run on personal computers have functions that generate random numbers. Although these random number generators may not be optimal, they will generally suffice. You can also download random number generators (e.g., <http://www.buffalo.edu/~rauln/random.html>) or

<http://nhse.npac.syr.edu/roadmap/algorithms/random.html>) or look up random numbers from printed tables.

Several techniques can be used to draw a random sample from a population that consists of individual objects or records (e.g., street addresses or tree numbers). Many spreadsheet programs, including Microsoft Excel® and Corel Quattro® Pro, include tools that can produce a random sample of a specified size from a range of cells. Alternatively, you can assign a unique random number to each unit or record, sort on the random number, and pick the required number of units from the top of the sorted database.

In some cases, it is necessary to take random samples across a geographic area, such as part or all of a city or forested area. In such a situation, random sample points can be assigned by randomly sampling from a coordinate grid that has been established for the area in question. This may either be an existing set of map-based coordinates, such as UTM or State Plane grids, or an arbitrary grid based on units measured on a map or aerial photograph (e.g., distances measured from the bottom and left edge of the map or photo). After you have determined the range of X and Y coordinates within the area to be sampled, X and Y coordinates can be selected randomly to generate random sample points.

## Stratified sampling

In many urban forestry applications, it is desirable to have samples distributed throughout the population. For instance, you may want to ensure that trees from each of several different maintenance districts are included in the sample. In such situations, stratified random sampling will be the most efficient and meaningful method for selecting samples. In this method, the population to be sampled is first divided into meaningful subunits or strata. These may be large subdivisions, planning sectors, maintenance districts, or any other convenient management or planning unit.

If strata are assigned so that each is more or less homogeneous with respect to the characters being measured, fewer samples will be needed to adequately characterize each stratum. For instance, if tree cover is to be assessed in different portions of a city, [visual estimates](#) of the tree canopy cover could be used to help demarcate zones where canopy cover is relatively uniform. A sample of street trees might be stratified by tree species, size, and/or age, depending on the purpose of the evaluation. If these trees were classified in a municipal street tree database, stratification might be accomplished relatively simply from existing tree data. However, if such data are lacking, it may be necessary to conduct a preliminary sample to delineate the population before sampling occurs. For example, in a study we conducted on utility pruning, we needed to sample from a population of matched pairs of London plane (*Platanus x acerifolia*) street trees that were both directly under conductors and had clearances within a certain range. Because existing tree inventories did not contain all of the necessary information, we surveyed the study area to identify a population of trees that met these criteria. These trees constituted a particular stratum of the street tree population.

Once strata are assigned and delineated, samples are drawn at random from within each stratum. If the number of samples selected from each stratum is not proportional to the size of the stratum, then the averages from each will have to be weighted to obtain an overall population average.

## Sample size

Optimal sample size will vary somewhat with the characteristics being rated or tallied.

In general:

- up to a point, the reliability of estimates will increase as sample size increases;
- the more variable the population is with respect to the characteristic(s) being rated, the larger the sample should be;
- a large sample is required to accurately estimate the frequencies of relatively rare events or characteristics;
- larger sample sizes are needed in order to detect relatively small differences between means or proportions; smaller sample sizes may suffice if the differences are relatively large.

The optimum sample size represents a compromise between cost and accuracy, since both generally increase with increasing sample size. You can determine an optimum sample size by identifying the point of diminishing returns beyond which further increases in accuracy are not worth the additional costs of data collection. Optimum sample size will vary with the type of data being collected, so it is not possible to set a single number for all applications.

However, you can use certain statistical formulas to estimate the **minimum** sample size needed for a specific purpose. A number of statistics web sites include on-line interactive calculators that allow you to estimate required sample sizes. Before you can use these sample size calculators, you will need to know several things about the data you are collecting and how it will be analyzed:

**Type of data.** Main data types include:

***continuous*** - variables can take any value, e.g., tree diameters

***discrete*** - variables can only have certain discrete values. Types of discrete data include

***ranks*** - ordered ratings, e.g. low, moderate, high

***counts*** - e.g., number of trees by species

***binary*** - variables have only two outcomes, e.g., present/absent. Binary data is typically expressed as proportions or percents, such as the percent canopy cover determined from dot grid counts (canopy is rated as present or absent for each dot).

**Type of analysis.** Continuous data are typically analyzed using linear models, including linear regression and analysis of variance techniques. Discrete data may be analyzed in various ways, including contingency table analysis, logistic regression, and survival analysis. Different formulas are used to estimate sample sizes for various analysis methods.

**Expected values.** To estimate sample sizes for analyses of continuous data you will have to specify estimates of expected population means (the Greek letter mu may be used for this term) and standard deviations or variances (the Greek letter sigma symbolizes the population standard deviation; variance is the square of the standard deviation). For proportions, estimates of the expected proportions are needed; margins of error (as percents) may also be needed.

**Data structure.** If data are paired or arranged in blocks or other more complex designs, the structure of the statistical model should be specified.

**Confidence level.** Also abbreviated as the Greek letter alpha, this is the probability of Type I error, the chance that you will say that a difference is significant when it really isn't (i.e., the probability of rejecting the null hypothesis when it is true). This is typically set a low level, often 5% ( $\alpha = 0.05$ ), meaning that there would only be a 5% (1 in 20) chance of deciding that a spurious difference is real (i.e., you have a 95% chance of avoiding Type I error).

**Power.** This parameter is the flip side of the confidence level, and is expressed as  $(1 - \beta)$  where  $\beta$  is the probability of Type II error. Power is the the probability of detecting a real difference (i.e., the probability of rejecting the null hypothesis when it is false). If you are interested in detecting real differences, the power of a test should be high, generally at least 80% (0.8) or greater.

## Links to sample size calculators

Some useful web sites with sample size calculators are listed below. Additional sites can be found by following links on some of these pages or by searching on the term "sample size" on various web search engines.

<http://www.stat.uiowa.edu/~rlenth/Power/> : **Russ Lenth's Java applets for power and sample size** -This site provides a variety of powerful but easy to use applets that allow you calculate sample size and interactively see how sample size, power, alpha, and other study design factors are interrelated.

<http://home.clara.net/sisa/index.htm> : **SISA: Simple Interactive Statistical Analysis** - This site includes a number of statistical analysis applications that can be run interactively online. It includes sample size calculators for both continuous and binary (proportion) data.

<http://www.health.ucalgary.ca/~rollin/stats/ssize/> : Four basic and easy to use Javascript-based calculators for sample size or power.

<http://www.answersresearch.com/calculators/sample.htm> : One of various basic sample size estimators used for public polling surveys. This provides sample sizes based on the margin of error desired in a survey. Several other survey-related calculators are also provided here.

<http://www.mc.vanderbilt.edu/prevmed/psintro.htm> : **Power and Sample Size Estimation** - A downloadable application (PS) for calculating sample size and power.

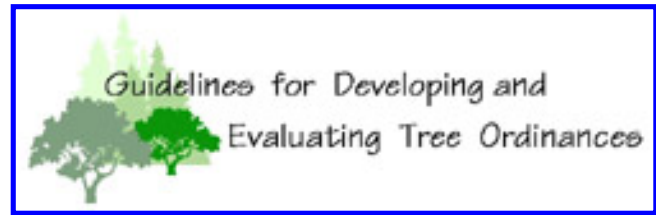

## Photogrammetry and remote sensing techniques

---

### Uses:

Measuring tree canopy cover either in wide areas or on specific parcels. If trees are widely spaced, estimates of tree density can also be determined. Changes in tree canopy cover due to tree mortality or removal can be determined by evaluating images made in different years.

### Materials needed:

- Aerial imagery of the area to be assessed. Imagery may be in black and white or color, including false color images produced from multispectral or hyperspectral digital images. Ideally, photographs should be taken during early to mid summer, when deciduous trees are in full leaf. Also, photos taken near midday have less shadowing and may be easier to interpret. Resolution of at least 0.5 to 1 m (about 1.5 to 3 ft) is generally desirable. The plane of photography should be parallel to the ground surface; orthorectified images are best.

### Measurements using dot grids counts

- a hand tally counter

#### For direct measurement from printed photographs:

- a dot grid reproduced on transparency material
- light box and/or magnifier is also useful

#### For measurements from digital images:

- computer hardware and graphics software capable of manipulating large image files. Software should also be capable of layering a dot grid graphic over the aerial image.
- scanner, if converting printed photographs to digital format

### Measurements using image analysis

- computer hardware and graphics software capable of manipulating large image files
- image analysis software
- scanner, if converting printed photographs to digital format

## Notes:

Although ground surveys can also be used to quantify canopy cover, photogrammetry has several distinct advantages over ground surveys:

- large areas can be measured at low cost;
- it is the only practical means of surveying areas with limited access;
- aerial photography coverage is already available in many municipalities;
- photographs provide a permanent record that can be reviewed or remeasured as necessary.

Coupled with other aerial photo interpretation techniques, photogrammetry can also be used to map the distribution of some tree species or forest types. It can also be used to monitor tree removal and mortality. However, aerial photos generally cannot provide detailed data on individual trees. Ground survey techniques are preferred or should be used in conjunction with photointerpretation when detailed condition or species data about individual trees is necessary.

Photointerpretation is also subject to **classification errors**, i.e., misinterpretation of the image. For example, tree shadows can be erroneously included as tree canopy or shrubs may be mistakenly classified as trees. Classification errors can lead to consistent overestimates or underestimates of canopy cover. Classification errors associated with image characteristics may be minimized by using the following types of images:

- color or false-color images that provide clear distinctions between canopy and shadow
- high-resolution images under magnification
- stereoscopic image pairs

A person skilled in photointerpretation is also less likely to make classification errors than a neophyte photointerpreter. Some field checking of photogrammetric results is advisable, especially when training new personnel or when imagery is suboptimal.

## Sampling considerations for photogrammetry

Certain photogrammetric methods (e.g., digital image analysis of multispectral imagery) are well suited to large areas, whereas others (e.g., dot grid estimates from large scale aerial photos) are better suited to smaller areas. If it is impractical to measure the entire area of interest, the area may be sampled using [stratified random sampling](#). Once sampling strata are assigned, the actual plot or area to be estimated should be chosen randomly. An easy way to do this is to establish a coordinate system based on the length and width of the area to be sampled. A [random number table](#) or random number generator can then be used to pick the starting location of each plot. For example, on a large aerial photo 55 cm wide and 81 cm long, the random number pair 35 and 68 would place a sample point 35 cm from the left edge and 68 cm from the bottom.

If canopy assessments are made on sample plots rather than the entire area of interest, the same plots should be resampled when comparing images taken in different years. If sample plots are remeasured, observed differences in canopy cover will be directly related to changes over time and will not include differences due to the spatial placement of the sample plot. The plot or sampled area should be noted on a map or a copy of the photo so that the same area can be relocated and remeasured in earlier or later images.

## Estimating tree canopy cover from aerial images



As reviewed by [Nowak et al \(1996\)](#), four different methods can be used to estimate tree cover from aerial imagery. Of these, the dot grid and digital image analysis methods are probably the most useful for many urban forestry purposes.

- [Visual \(ocular\) estimation method](#)
- [Dot grid method](#)
- [Line intercept or transect method](#)
- [Digital image analysis methods](#)

## Visual (ocular) method for estimating canopy cover

In this method, polygons (such as a grid of squares) are superimposed on the image and the evaluator makes a visual estimate of the tree cover in each polygon or a sampling of polygons. A comparison template showing different percentages of cover is normally used as a guide. An example of such a template is shown below (source: USDA FS FIA manual <http://fia.fs.fed.us/library.htm#Manuals>). Numbers above the columns of ovals refer to the percent black within the oval.

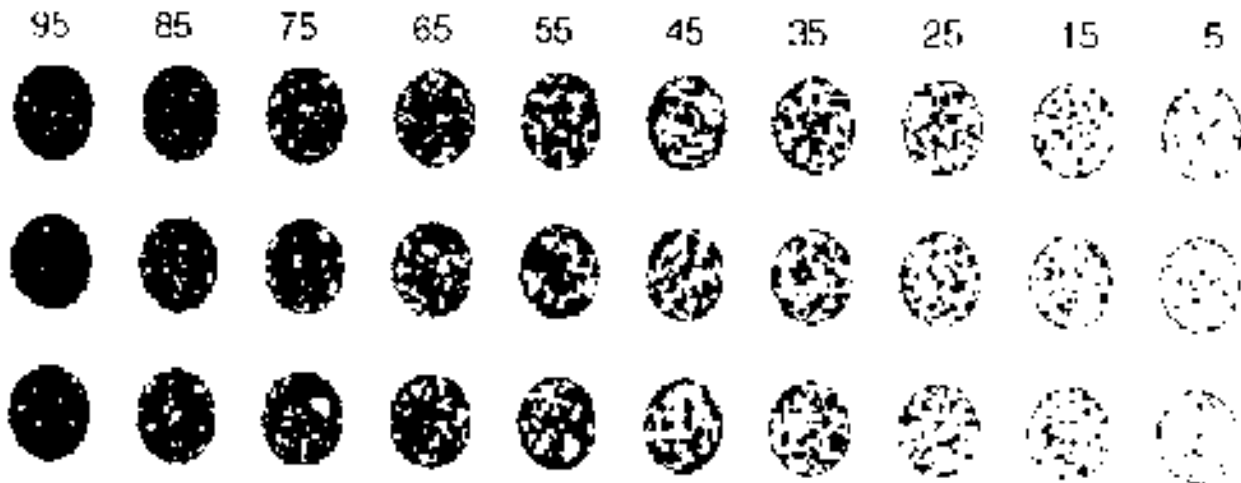

This method is relatively easy to use, but is not precise. Canopy estimates may be somewhat variable, especially between different estimators. Furthermore, estimates tend to be more precise at very high or low canopy cover levels and less precise when canopy cover is nearer to 50%. This method is probably most useful for making preliminary estimates of canopy cover. For example, visual estimates can be used to distinguish between areas with high and low levels of canopy cover when assigning canopy cover strata for a [stratified sample](#). In such cases, the canopy cover class can be estimated using an appropriate [rating scale](#) rather than attempting to estimate the actual cover class percentage.

## Dot grid method of canopy estimation

This is an easy, accurate, and relatively rapid method for determining canopy cover, and is equally applicable to natural woodlands and planted urban forests. A dot grid is simply a set of dots, symbols, or intersecting grid lines that is superimposed over an image. Tree canopy cover is estimated by counting the number of dots that fall on tree crowns compared with the total number of dots in the area sampled. Tree canopy cover can then be calculated from the following formula:

$$\% \text{ canopy cover} = 100 \times (\text{dots falling on tree canopy} / \text{total number of dots within sampled area})$$

**Types of dot grids.** Regular, uniformly-spaced grids are most commonly used, but the dots (sample points) can also be arranged in a spatially stratified random pattern. **If you are using printed photographs**, a sheet of transparent material imprinted with dots is laid over the photo. The dots may be easier to resolve if a light box is used under the photo, and magnification may be necessary if tree canopies are small in the photo. Dot grids to be used with photographs can be purchased from forestry equipment suppliers or you can produce your own by printing a grid developed with graphics software onto transparency material (view an example of a [uniform dot grid](#) here). **If your aerial imagery is in digital format**, the dot grid can be superimposed over the photo using graphics software. If the grid is fixed in place (generally by grouping the grid and the underlying image), you can use your graphics program's zoom function to examine the image and dot grid at whatever magnification is necessary to resolve tree canopies clearly. An example of the use of a digital dot grid is shown in the page [Comparison of image analysis and dot grids for calculating tree canopy cover](#).

**Sources of error.** Dot grid counts are subject to both [classification errors](#) and sampling error. If sample size is adequate (see following discussion), random statistical error can be minimized. [Sampling bias](#) may be a problem if a regular dot grid is superimposed on a photo with features that repeat in a regular pattern, such as rectangular city blocks. You can use a stratified random dot grid, or make sure that the dot grid is always skew relative to the street grid to minimize this type of sampling bias.

**Sample size.** How many dots do you need to count? The answer to this question is not simple. Various sampling considerations are discussed and illustrated on the page [Determining sample size for dot grid estimates](#). Although counting high numbers of dots can be tedious, it can be accomplished fairly quickly if the contrast and resolution of the aerial image are good. Sample size may be increased either by using a denser dot grid or by randomly repositioning the grid over the image and recounting. Data from several independent counts of the same area can be aggregated to produce an overall estimate of canopy cover.

### **Evaluation example: *Overall canopy estimates in permanent plots***

In 1990, we examined two sets of aerial photos maintained by the Planning Department of the City of Riverside, California. The older set was photographed in 1974, and the newer set was taken in 1988. Both sets are printed at 1:2,400 (1 inch = 200 feet). This photography constitutes a valuable resource for documenting the extent of the urban forest and changes occurring over that 14 year span.

Using the dot grid method, we rated the overall canopy cover on five randomly selected plots in an established residential area on the 1974 photographs. The same plots were relocated and rated in the 1988 photos. Estimated canopy cover averaged 22.3% in 1974 and 22.7% in 1988, an insignificant change. Over this period of time, a moderate level of canopy cover was apparently conserved with the current plantings and management practices within the sampled area.

### **Line intercept or transect method**

This method is analogous to the dot grid method and provides similar levels of precision. In this method, lines are superimposed on the aerial image and the length of each line that overlays tree canopy is compared to the total line length. Canopy cover is then calculated as follows:

$$\% \text{ canopy cover} = 100 \times (\text{length covered by tree canopy} / \text{total length of sample})$$

Lines may be printed on a transparent sheet or can be designated by randomly positioning a clear plastic ruler on the photo. If streets or other features are arranged in parallel lines, sampling bias is best avoided by using a random arrangement of lines rather than parallel lines on the sampling overlay. Accuracy is improved by using more short lines rather than few long lines.

The line intercept and dot grid methods can be also be combined as follows. A line with periodic points (regularly or randomly spaced) is superimposed over the image and the number of points that fall on tree canopy is recorded. Percent canopy is calculated as for the dot grid method, i.e.,

$$\% \text{ canopy cover} = 100 \times (\text{points falling on tree canopy} / \text{total number of points along sampled lines})$$

The line intercept or hybrid point-line method are especially useful for measuring tree canopy along streets (see [Measurement of Canopy Cover at the Edge of Pavement \[CCEP\]](#)).

## Digital image analysis methods

Any image you can view and store on a computer is referred to as a digital image. The word **digitize** generally refers to the process of converting images to a digital format, but it is also used to describe the conversion of raster-based images to vector-based format. **Raster** images are collections of pixels, which can be thought of as small squares in a very fine grid. Each pixel is associated with information on color value and intensity for that portion of the grid. Images in **vector** format are in the form of points, lines, and closed figures called **polygons**. Points are described by coordinates and the positions, directions, and shapes of lines are described by geometric and mathematical relationships. Although GIS and CAD software work with both raster and vector data to varying degrees, vector data are used for most mapping applications.

There are several ways to convert raster data, such as aerial photographs showing tree canopy, to vector data. Manual digitizing involves the use of a handheld digitizer and digitizing tablet to trace tree outlines and directly produce tree canopy polygons. Alternatively, digital image can be displayed on a computer screen and tracing of the image is done on-screen using the computer mouse. This is referred to as "heads-up" digitizing. Specialized "interactive tracing" software can be used to facilitate the process further. The [CITYgreen extension](#) to ESRI ArcView GIS software uses a shortcut method that represents tree canopy as circles which are superimposed on the image through heads-up digitizing. Finally, some software uses image processing and pattern recognition techniques to automatically convert raster to vector data, especially printed material such as maps and plans. Once information such as tree canopy is represented as vector-based polygons, GIS and CAD programs can use these polygons directly to determine their total area, which can be used to calculate percent canopy cover.

Raster image data can also be used to calculate tree canopy cover directly, but some manipulation of the image is typically needed before canopy cover can be calculated. In most types of imagery, including black and white or color images that have been scanned or captured with digital cameras, items of interest such as tree canopy are typically represented as a collection of pixels that vary in color and/or intensity. Image analysis software uses a variety of techniques to convert an image into a series of monochromatic layers, each of which represents a single type of feature. Once all trees are represented as pixels of a unique value that differs from that of all other features, the percent canopy cover can be calculated. It may also be possible to differentiate between different types of tree canopy using image analysis software. The page [Comparison of image analysis and dot grids for calculating tree canopy cover](#) shows one way that basic image analysis techniques can be used to produce a raster-based image layer of tree canopy cover.

Digital image analysis techniques have the potential to provide precise estimates of canopy cover, but

photointerpretation errors can still result in [bias](#) due to misclassification. Sampling errors can also still be important, particularly if analysis is conducted only on representative sample areas instead of the entire management unit. The costs and effort associated with these methods can be relatively high unless the necessary computer hardware, software, and trained personnel are already on hand. Even if the resources to perform these analyses are readily available, it will typically take much more time to assess canopy cover using either raster or vector image analysis techniques than by using dot grid counts. However, digital image analysis can create permanent maps of tree canopy distribution that may be incorporated into a GIS and/or used to show how and where tree canopy distribution changes over time. If data will be used for these other purposes, the additional cost of digitizing tree canopy can probably be justified.

### **Other resources:**

Western Center for Urban Forest Research and Education - <http://wcufr.ucdavis.edu/urbanforestinventoryandmonitoring.htm>

Dct grid: 400 dots total

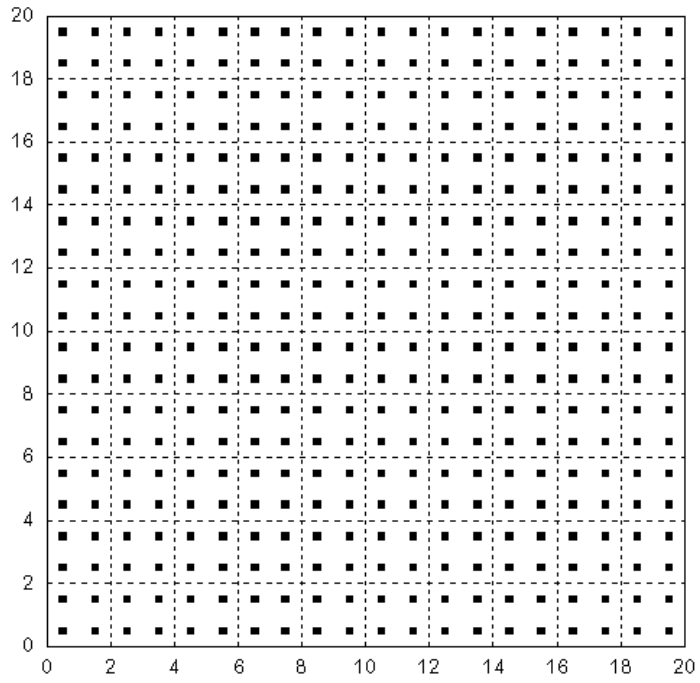



## Determining sample size for dot grid estimates

If you are using the [dot grid method](#) to assess tree canopy cover, how many dots do you need to count? Unfortunately, there is no single answer to this question, but you can calculate the [minimum sample size](#) of dots required for a given application if you have some basic information about the population. Several basic principles apply when determining the necessary sample size. First, the reliability of the canopy cover estimate will increase as the dot density increases, but the increase in [statistical power](#) begins to plateau at high sample sizes. This effect is evident when power is plotted against sample size ([Graph 3-1](#)). Larger sample sizes are needed when making comparisons between similar canopy cover levels (e.g., comparing tree cover changes over time due to natural mortality) than when comparing widely different canopy levels (e.g., comparing tree cover in residential and industrial areas) ([Graph 3-2](#)). Also, the sample size needed to detect a difference of a given magnitude (e.g., 10%) increases as the percent cover approaches 50% ([Graph 3-3](#)).

The upshot of this is that almost any application will require a count of at least 300-400 dots. If you need higher precision or if you need to differentiate between levels of canopy that are close to 50%, the minimum dot count will be closer to 500, and higher numbers would be preferable.

### Graph 3-1. Power, confidence, and sample size

The graph below shows the general shape of a sample size power curve. All of the curves shown on this page are based on the formula for a test comparing two proportions ( $p_1$  and  $p_2$ ). [Power](#) is plotted on the vertical axis and sample size is on the horizontal axis. You can see from the graph that power increases with increasing sample size, but the slope of the curve decreases progressively as sample size increases, that is, you reach a point of diminishing returns. For example, at alpha (or [confidence level](#)) = 0.05, sample size needs to be increased by about 200 to increase the power from 0.6 to 0.7, but it needs to be increased by about 450 to increase the power from 0.8 to 0.9. The graph below shows curves for two different levels of alpha. For a given level of power, a larger sample size is needed to obtain a higher confidence level.

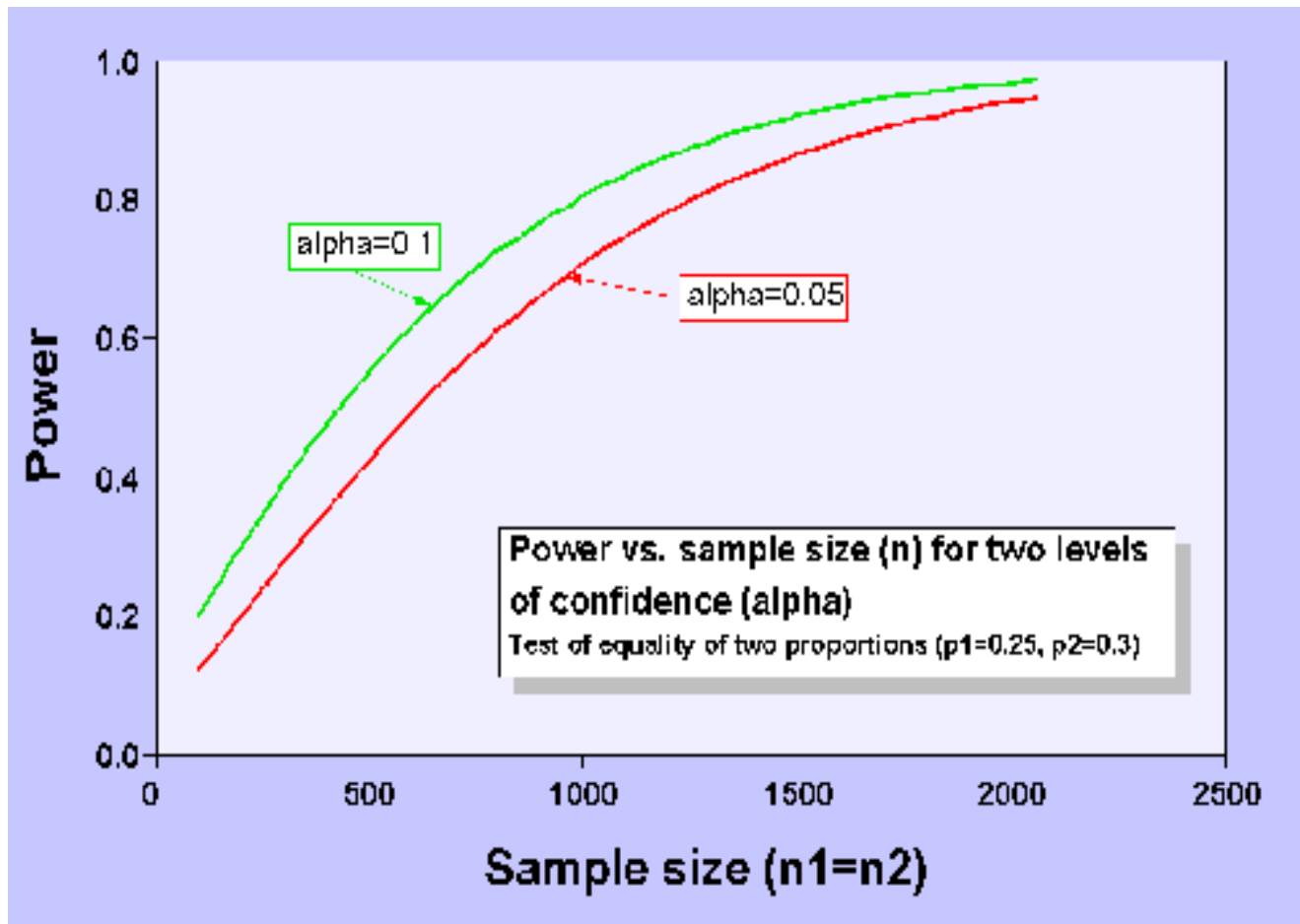

### Graph 3-2. Sample sizes for detecting differences of various magnitudes

As illustrated in the graph below, sample size must increase to detect relatively small differences at a given level of [power](#) and [confidence](#). In the example shown, at  $\alpha=0.05$  and  $\text{power}=0.8$ , a sample size of about 170 dots will suffice for detecting the difference between 30% and 45% canopy cover, but a sample size of 1400 dots is needed to detect a real difference between 30% and 35% canopy cover. Looking at this effect another way, at a sample size of 400 dots, a statistical difference between 30% and 45% canopy will be detected more than 99 times out of 100; a difference between 30% and 40% canopy will be detected about 85 times out of 100, but a difference between 30% and 35% canopy will only be detected about 33 times out of 100.

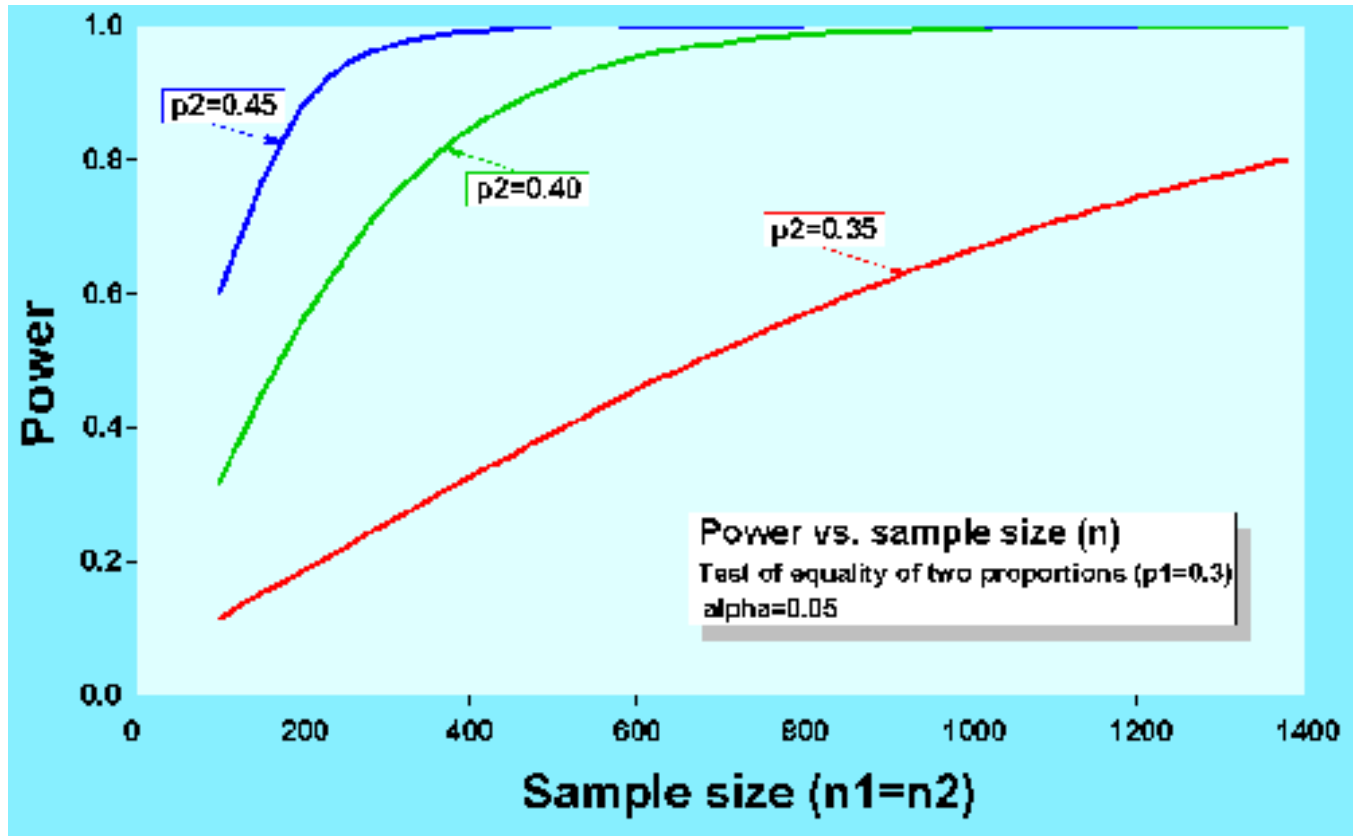

### Graph 3-3. Required sample sizes increase as proportions approach 0.5

In the graph below, the magnitude of the difference to be detected is the same for all three curves (0.1). You can see that progressively larger sample sizes are needed to obtain a given level of [power](#) as the proportions approach 0.5. This relationship is symmetrical around the center of the range (0.5). Thus, the curve for the pair  $p_1=0.9$  and  $p_2=0.8$  is the same as the curve for the pair  $p_1=0.1$  and  $p_2=0.2$ .

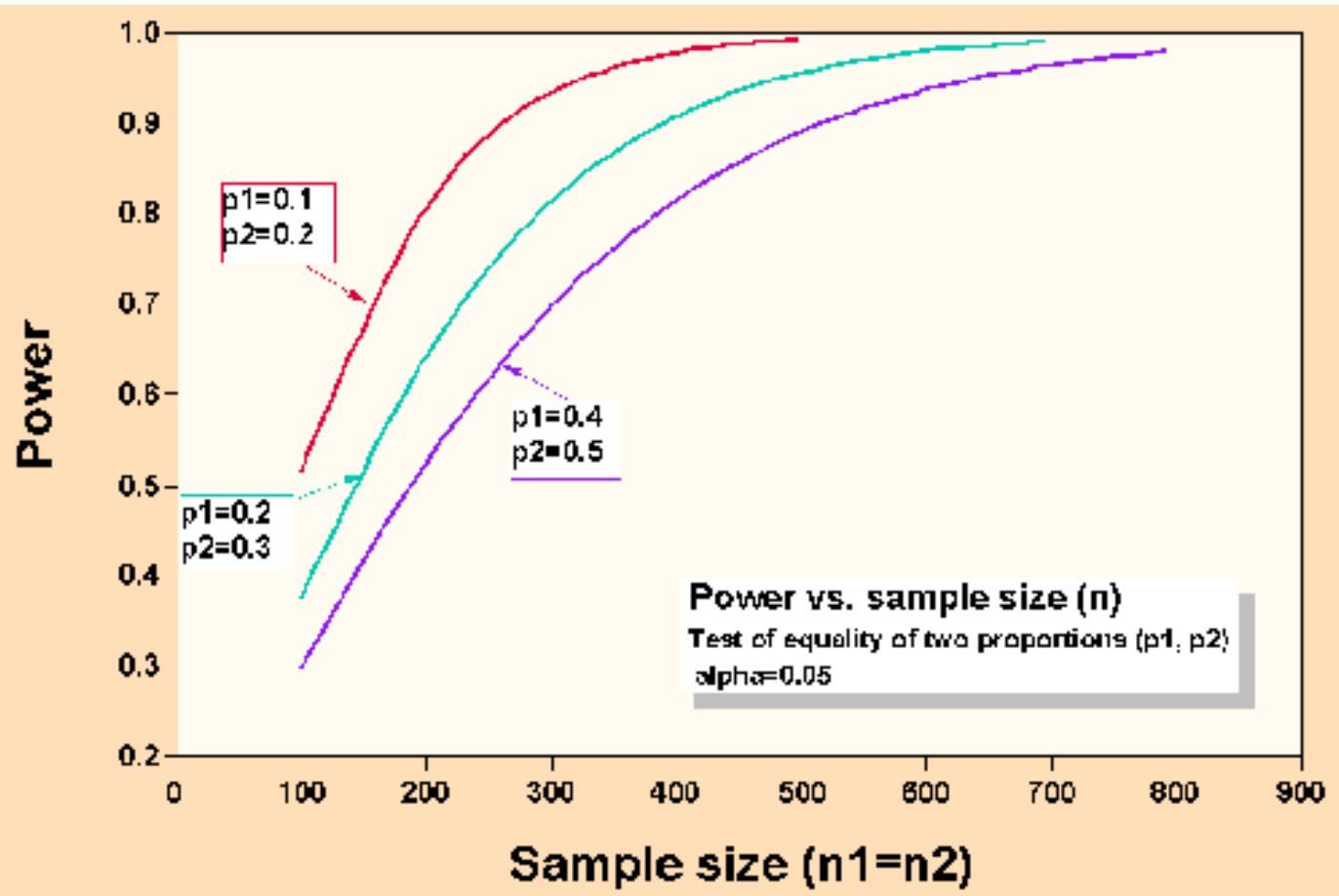





## Comparison of image analysis and dot grids for calculating tree canopy cover

---

As discussed under [Photogrammetry and remote sensing](#), tree canopy cover can be assessed from aerial photos using a variety of methods. Some of the methods are simple, while others are relatively sophisticated. Both the time required to make the assessment and the accuracy of the assessment can be influenced by the method used. On this page, we compare two methods for assessing canopy cover: a scan of a black and white 1:6000 aerial photo obtained from a commercial vendor. Canopy cover on the same image was also measured using another image analysis method on the page [Evaluation example: CITYgreen software for ArcView GIS](#).

**Image analysis method.** One technique that can be used to measure tree canopy cover with image analysis software involves converting a grayscale or color image into a black and white image that consists only of canopy (black) and 'not canopy' (white). This type of conversion can be accomplished using image analysis software alone or in conjunction with standard graphics software. For image analysis, we used ImageTool software (ver. 2 alpha) for Windows, which was developed at the Department of Dental Diagnostic Science at The University of Texas Health Science Center, San Antonio, Texas. The software can be downloaded for free from FTP sites listed at <http://ddsdx.uthscsa.edu/dig/itdesc.html>. We also used Adobe Photoshop graphics software to make certain image manipulations. The steps we used to calculate tree canopy using this image analysis technique are described and illustrated below.

**Digital dot grid method.** Dot grid counts of canopy can be performed on digital images by creating a computer graphic grid, superimposing it over the image, and manually counting the number of dots that occur over tree canopy. We used Lotus Freelance Graphics software to create and superimpose the dot grid, although other general graphics software could be used similarly.

<b>Step 1. Image acquisition.</b>	
-----------------------------------	--

For both methods, we needed a digital image. In general, a relatively high resolution scan is preferable. The example was scanned from a black and white aerial photo (1:6000) at 1200 dpi, 256 shades of gray. The scanned image was	
---------------------------------------------------------------------------------------------------------------------------------------------------------------------------------------------------------------------------------------	--

then cropped to include only the area of interest. For this example, the subject area is a rectangular parcel covering about 108 acres.

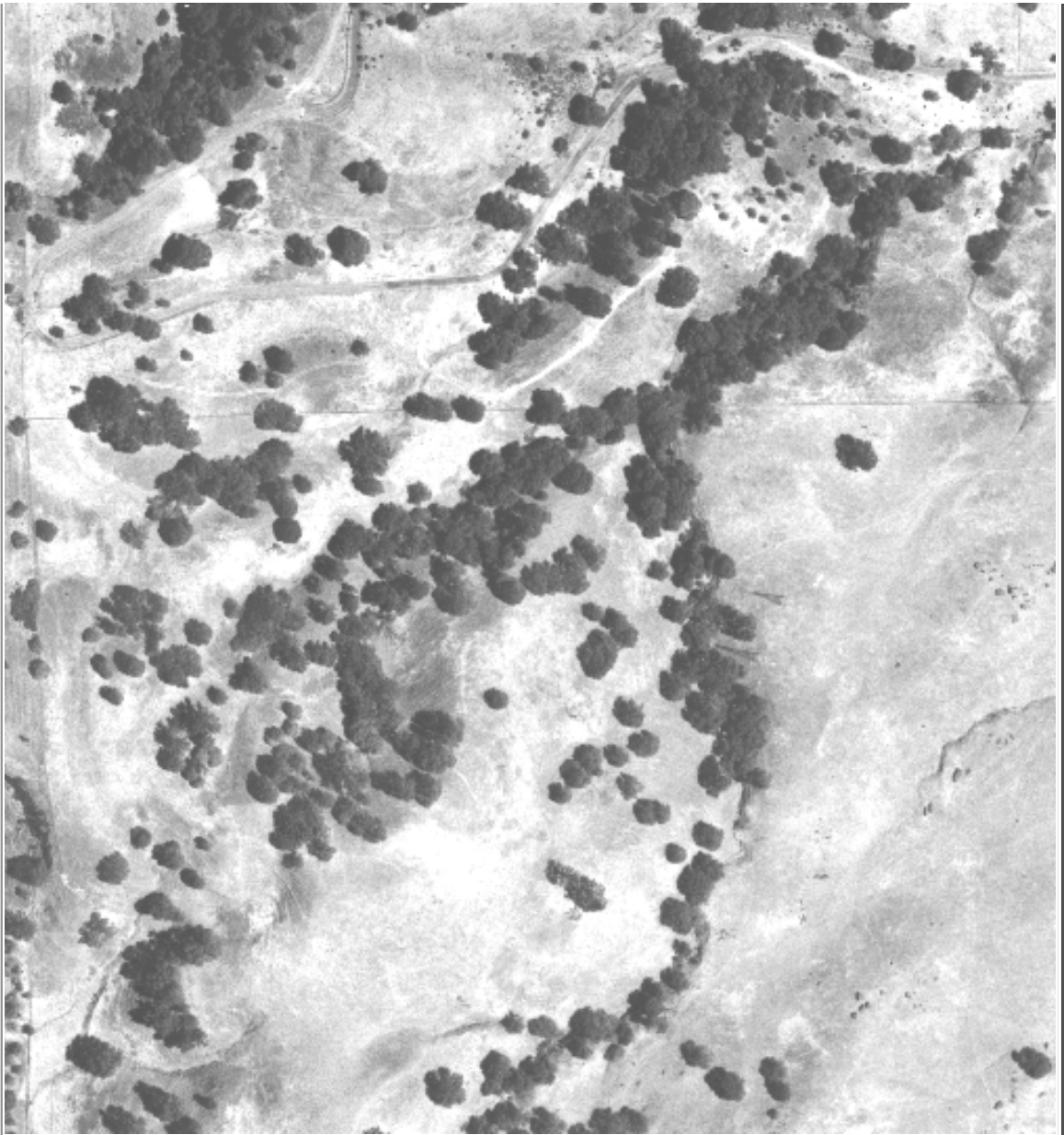

**Step 2.**  
**Increase contrast and clean image.**  
Using tools available in the graphics software (Photoshop), we cleaned the image manually to remove materials other than tree canopy, including the shadows cast by the canopies. This

involves the iterative use of contrast-enhancing tools, erasing tools, and the "magic wand" tool that allows for the selection of contiguous areas of a given color value. The image shown is the result of these edits.

After this step was completed, we used the "posterize" function to reduce the total number of gray levels to 10 before some final cleanup of the image. The posterized image is not shown.

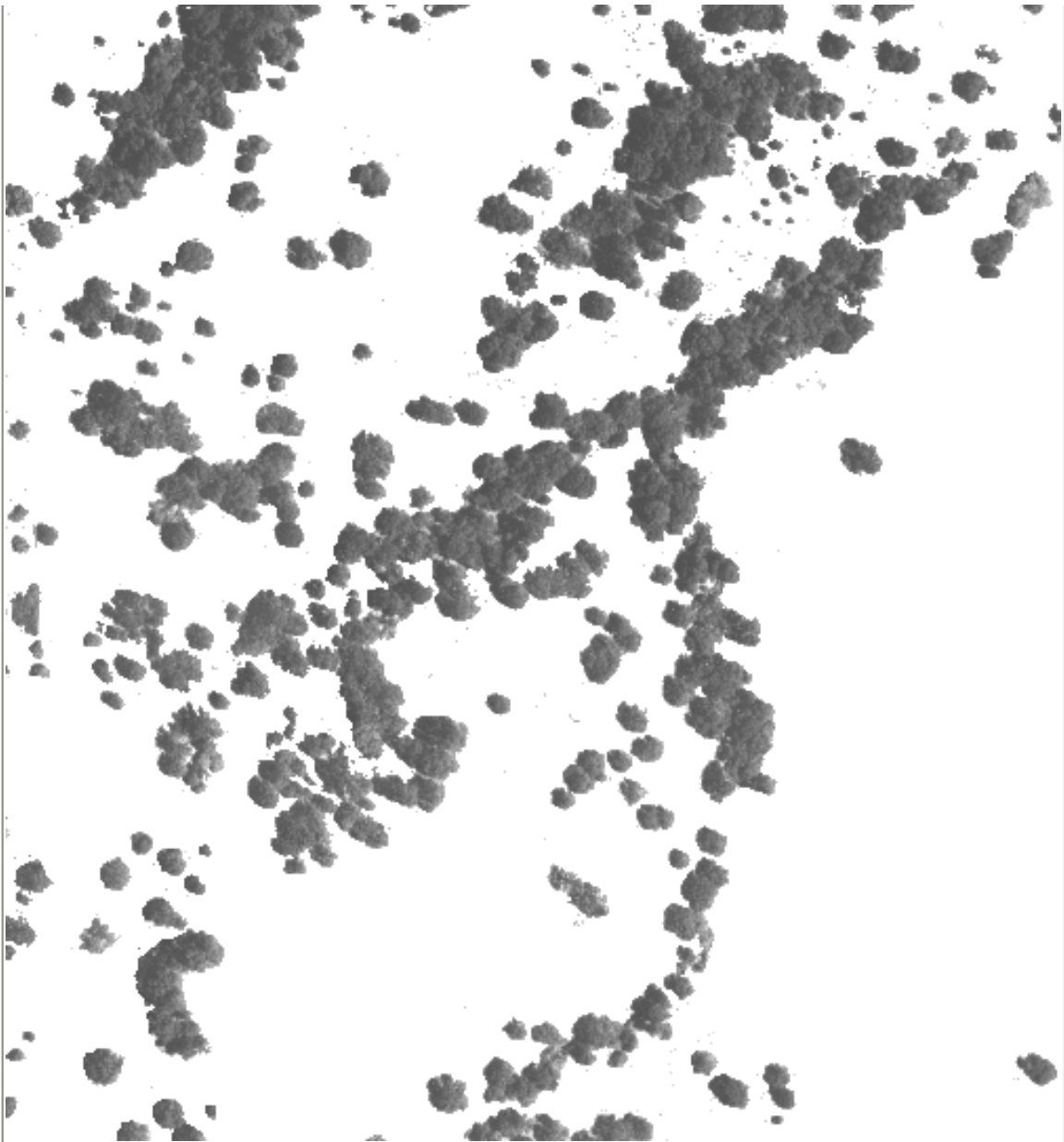

**Step 3. Threshold image.** Thresholding a monochrome image involves picking an intensity value above which all pixels will be converted to black and below which all pixels will be converted to white. Because virtually all

non-canopy areas have already been converted to white pixels in the previous step, thresholding only involves converting the remaining gray tones to black pixels. If the contrast between tree canopy and the background had been greater in the original image, thresholding alone could have produced a fair approximation of canopy cover.



**Step 4. Recheck and edit thresholded image.** To improve the accuracy of the thresholded image, we converted the thresholded image to a color (RGB) version, eliminated the white pixels using the magic wand tool and used



Photoshop's layering functions to superimpose the thresholded image over the original photo image. This allowed us to adjust the thresholded image to more closely approximate actual canopy cover. We erased thresholded canopy from areas it did not belong and added additional canopy as needed (using drawing tools) to fill in areas of canopy that had been eroded in previous steps.

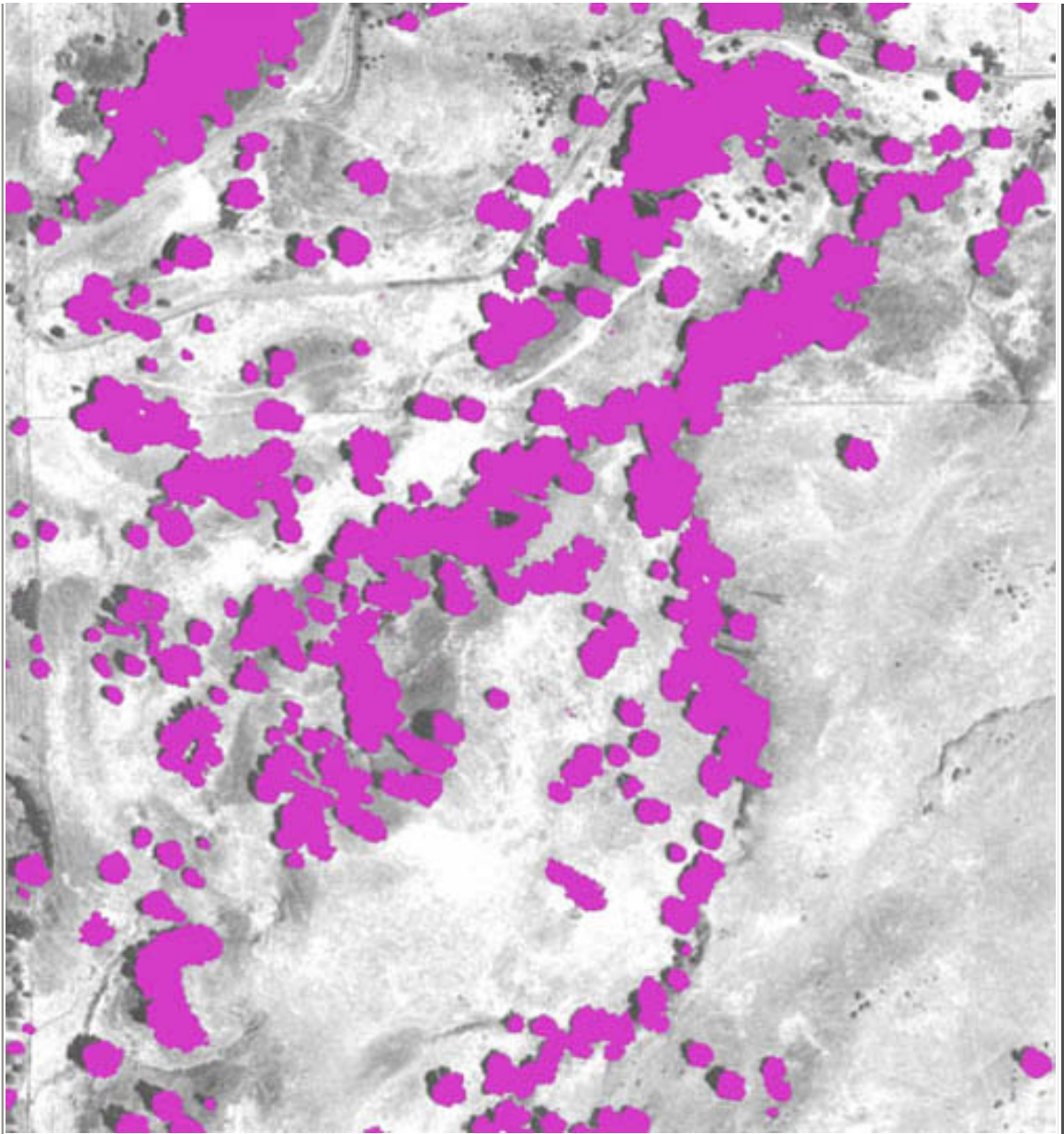

**Step 5. Calculate % canopy cover.** The color canopy image layer needed to be reconverted to grayscale and re-thresholded in ImageTool before the program would calculate the number of black and white pixels. Although the final image

included some stray black pixels that were not tree canopy, there were not enough to affect substantially the accuracy of the canopy estimate. Since ImageTool directly counts black and white pixels, this determination is not a source of error. Rather, the degree to which the thresholded image coincides with canopy cover determines the accuracy of the canopy cover estimate.

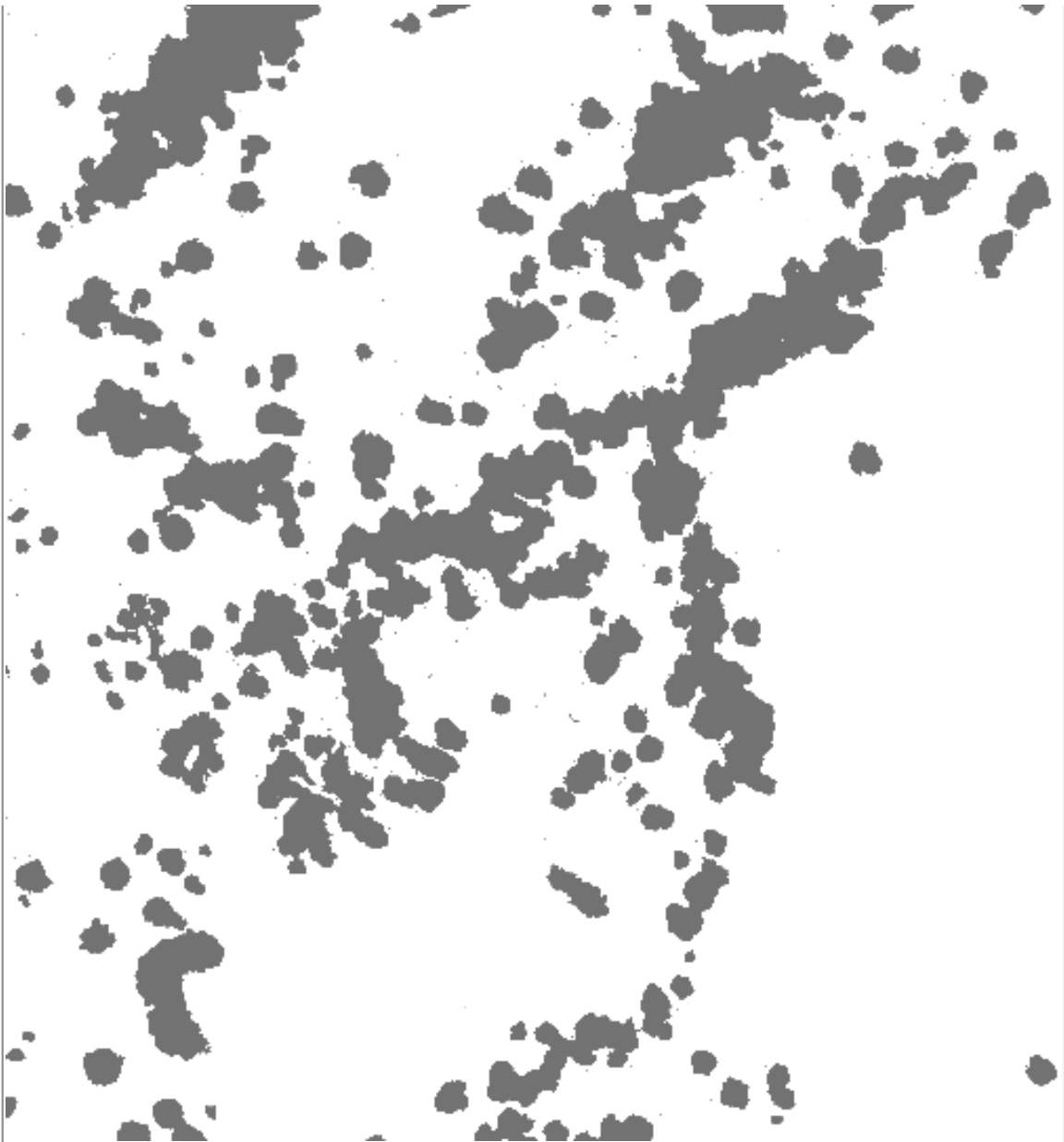

**Using a digital dot grid.** The image to the right shows how a digital dot grid overlay can be used to calculate canopy cover. We used open triangles rather than dots in order to produce an easy to locate, precise dot that would not obscure

the underlying image. The sample point or "dot" is one vertex of the triangle. A uniform dot grid can be produced by preselecting a given vertex (e.g., lower right) for all triangles. To increase the precision of the estimate, we made three dot counts, shifting the grid randomly before each replicate count. Each count included 294 dots, so the total sample size was 882 dots. We zoomed in on the image as needed during the counts to make more accurate distinctions between canopy and shadow; the red lines were used to help keep track of our position on the grid when the image was magnified.

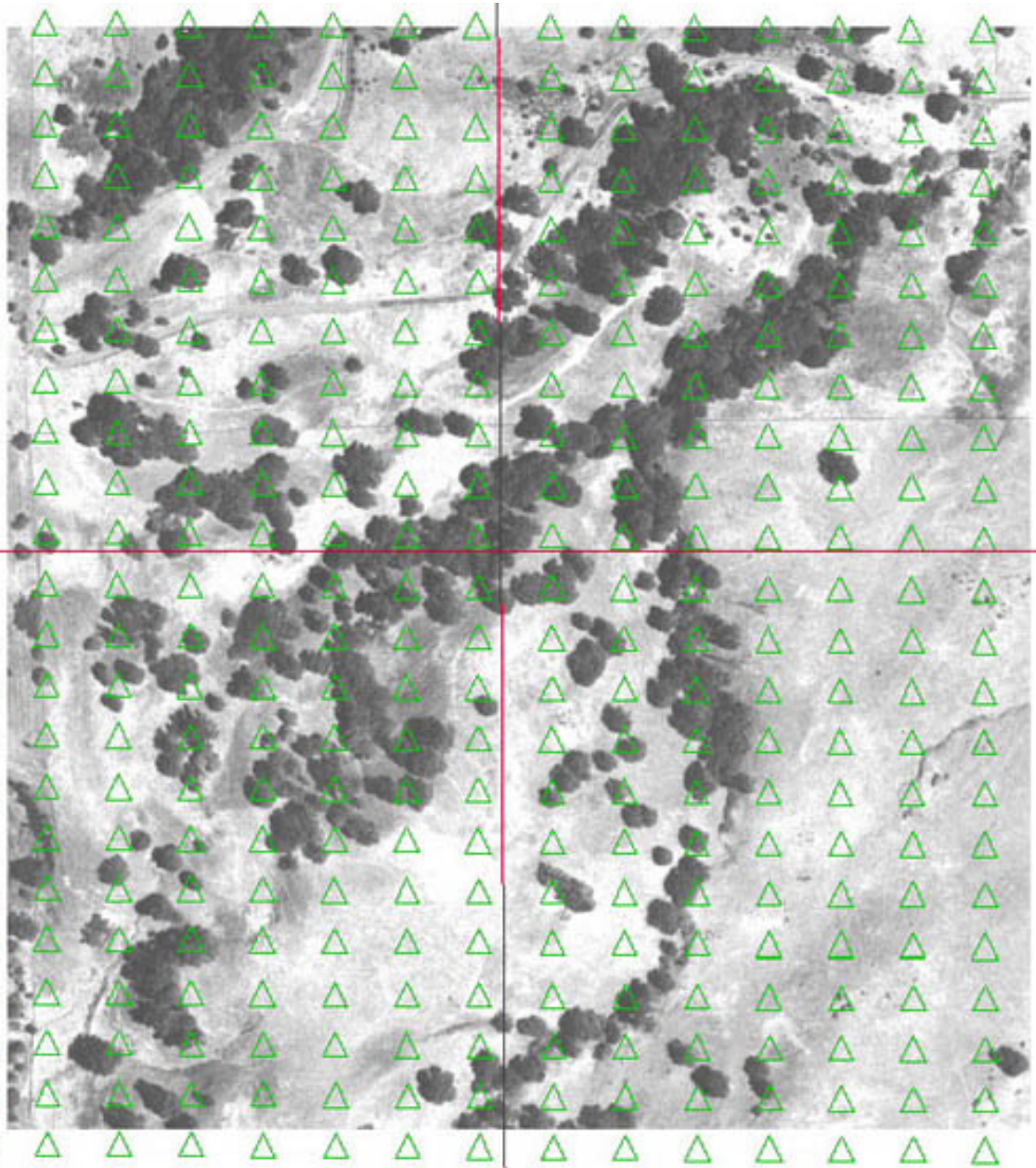

**Results.** Using the image analysis method described above, the ImageTool software calculated that canopy covered 20.78% of the final edited image in Step 5. By comparison, using dot counts of the thresholded image shown in Step 6 we estimated canopy cover at 21.4% (a difference of 0.6%). Dot counts on the original aerial scan resulted in a estimate of 20.97% canopy cover. Processing the scanned photo for image analysis required about 4 hours more time than was required for estimating canopy cover using dot counts on the original scanned image, although the extra time required would vary with the characteristics of the image and the editing tools being used. Although it clearly required more time than dot counting, the image analysis method produced an image of tree canopy cover that could be overlaid on earlier or later aerial images (e.g., using GIS or graphics software) to directly show where changes in canopy cover have occurred. This may be especially useful for determining where trees have been removed. Note that accurate interpretation of canopy by the human analyst is required to obtain accurate results using either method.





## Ground survey

---

### Uses:

Measuring various tree characteristics, including species, age, size, health, and damage factors.

### Materials needed:

- Maps of areas to be sampled
- Data sheets
- Hand tally counters (especially useful for keeping counts in windshield surveys)
- Measuring equipment (varies with objectives - may include tape measures, rangefinders, GPS receivers, etc.)

### Notes:

The ground survey is one of the most basic methods for gathering urban forestry data. Ground surveys typically are used to gather the baseline data for most tree inventories. The ground surveys used in urban forestry are of two general types, commonly referred to as [windshield surveys](#) and [foot surveys](#). Details of each type are discussed below. When resources are insufficient to conduct a complete inventory, a representative sample of the urban forest can often provide sufficient information for making management decisions and monitoring progress. Furthermore, when natural woodlands or forests are managed, as in parks and open spaces, a complete inventory is usually unnecessary and impractical.

## Sampling considerations for ground surveys

If less than a complete survey is planned, plot selection should proceed as outlined under [Sampling from Populations](#). To provide estimates of size and condition of street trees, researchers working in several cities in the eastern U.S. ([Valentine et al 1978](#)) arrived at the following recommendations, which can be used as a rough rule of thumb for planning ground surveys:

- 1. Sample 50 to 100 randomly-selected streets (plots). Plots may consist of two to three city blocks.
- 2. A total of 100 trees of each species or class of trees being studied should be represented in the overall totals.
- 3. For the most common tree species, a predetermined sampling interval should be used to keep the total number of sampled trees down to 100 or so.



The use of a sampling interval is not strictly necessary, but reduces the amount of effort involved. To use a sampling interval, some information about tree species incidence is required in advance. As an example, suppose you plan to sample 50 plots, and London plane is likely to occur in almost all plots. To have 100 London plane trees represented in the overall sample, it will only be necessary to tally two or three per plot. If you anticipate that ten London plane trees will occur in a typical street section, then only one out of every five London planes needs to be tallied. When using a sampling interval, the selection of the sampled trees must be unbiased. Don't just skip those that look good (or bad) or are difficult to read; use a regular interval. Finally, the sampling interval needs to be taken into account when the data are tabulated, to show the actual incidence of these tree species.

## The windshield survey

This technique is most suitable when the data to be collected consist of one to a few obvious characteristics. It is also useful for rating characteristics that occur at relatively low frequencies. One person drives a vehicle in which one or more evaluators tally data using tally counters and data sheets. Data collected should consist only of counts of trees that have or lack a particular characteristic or fall into a limited number of categories. The greatest advantage of this method is that it is relatively fast and inexpensive. The main drawback is that only a few characteristics can be rated for each tree. If an evaluator attempts to rate too many characteristics from a moving vehicle, either accuracy will suffer or the driver will have to slow the rate of travel to an impractical speed. The foot survey should be used if a number of detailed observations are to be made on each tree. Examples of some of the characteristics that could be rated in a windshield survey include:

**-Canopy dieback.** This is a simple indicator of tree health. Either tally trees above and below a given cutoff value (e.g., dieback affecting more than 1/3 of the crown), or use 3 to 4 categories (e.g., low, moderate, severe, tree dead). If descriptors such as "low" or "severe" are to be used, it is necessary to establish specific criteria for each description (e.g. low= less than 20% of crown affected) to minimize differences that may arise between different evaluators. Photographs that illustrate the different classes are very useful to ensure uniformity between different evaluators and different years.

**-Improper pruning practices.** Topping and other poor pruning practices are especially obvious in winter after leaf fall.

**-Prohibited practices,** such as vandalism, or attaching signs or wires to trees.

**-Specific disease and pest problems.** If surveys are timed to coincide with periods when disease or insect pest problems are most obvious, it may be relatively easy to document the extent and incidence of the problem. For example, leafy mistletoe in deciduous trees is easily rated in the winter months, whereas branch dieback in alder caused by flatheaded borers is most obvious in summer.

**-Tree type.** Trees can be placed into relatively broad categories based on height or type (e.g., conifers, evergreen hardwoods, deciduous hardwoods) fairly readily. Also, the frequency of a single or a few distinctive tree species could be tallied. However, especially in areas where a wide variety of tree species are used, a complete tally of trees by species would be difficult or impossible to conduct from a moving vehicle.

**-Trunk diameter.** For many, though not all tree species, diameter serves as a useful indicator of tree age. Several broad classes of tree diameters (e.g. less than 6 inches, 6- 24 inches, greater than 24 inches) can be distinguished with enough accuracy to be used in a windshield survey.

**-Planting site characteristics.** Empty planting spaces, severe sidewalk displacement, and other obvious site characteristics can be tallied.

### **Evaluation example: *Windshield survey for tree topping incidence***

Some cities prohibit tree topping in order to maintain trees in good health and a safe condition. Before deciding to enact such a provision or adopt other management actions, it would make sense to collect some baseline data on the prevalence of this undesirable practice.

We conducted a preliminary windshield survey to determine the incidence of tree topping in residential areas of the City of Vacaville. Twelve sample plots were established using randomly-generated coordinates as described under [Sampling Considerations For Photogrammetry](#). From the intersection nearest to each random point, we traveled a predetermined route for a distance of about one-half mile, which generally allowed at least 40 trees to be tallied. We looked at mature hardwood trees in front and side yards, and tallied the total number of trees with and without evidence of topping.

Rating the 12 plots took a little over an hour. In all, 681 trees were tallied, of which 26% (180) had been topped at some point. The incidence of topping varied widely between neighborhoods, ranging from 0 to 53%. Although we did not tally topping data by species, it was obvious that Modesto ash (*Fraxinus velutina* 'Modesto') and fruitless mulberry (*Morus alba*) were topped most frequently.

Our preliminary sample did not include enough areas of the city to provide a reliable estimate for topping incidence citywide, but clearly shows that the magnitude of the problem is significant. Based on a more complete sample, the city might consider a variety of options including educational programs, a phased tree-replacement program, tree selection guidelines, and an anti-topping provision. By comparing the base line percentage of topped trees before action with levels in subsequent years, the city could determine whether the actions taken were effective.

## **The foot survey**

When detailed information in a number of different categories is to be collected, the survey should be conducted on foot. All of the examples listed above under the windshield survey could also be evaluated in a foot survey. Some data may be expressed as categories, as in the windshield survey, but it is also possible to

take more detailed data and actual measurements rather than use generalizations and estimates. For example, stem diameter can be measured rather than estimated and trees can be identified to species. The type of planting space (for example grass, bare soil, depressed well, level well, raised planter) and size of the planting space can be identified. Tree condition, hazardous trees, hardscape damage, and site conditions can be inspected and evaluated more thoroughly in the foot survey than in the windshield survey.

If data are being collected for an inventory, such as a street tree inventory, data are typically collected for every tree in the area of interest. If forests or woodlands containing large numbers of trees are being evaluated, it is more efficient to sample the area rather than conduct a complete survey. Sampling may occur using plot-based or plotless techniques (e.g., point-centered quarter method). Plots may be arranged in various shapes and sizes, and plots of varying sizes are sometimes nested within each other. Plot area can be either fixed (e.g., circular 0.2 acre plots) or variable (e.g., prism-based plots). Plots may be permanent, which allows for direct observations of changes that occur over time. Given the wide variety of sampling methods available for measuring forest attributes, persons that specialize in forest survey methods (e.g., university forestry department faculty, forestry consultants, state and federal forestry staff) should be consulted before undertaking a forest survey.

Plot or tree locations can be noted directly on maps or aerial photos. Standard survey techniques can also be used to pinpoint tree locations. With the decreased cost and increased precision of GPS (Global Positioning System) technology, the use of hand-held GPS receivers provides another way to determine tree or plot coordinates in the field. However, GPS readings from low cost units are subject to several sources of error that can degrade the precision of location information. In particular, tree trunks, branches, and canopy can interfere with the reception of satellite signals needed to obtain coordinates. We have been able to achieve improved reception by using a high-gain external GPS antenna mounted on a mast that can be elevated at least part of the way into the canopy.

Some common measurements recorded in foot surveys are described below.

## **Tree size**

Measurements of tree size can include such measurements as tree canopy spread, diameter at breast height (DBH), and tree height. Within species, DBH is generally correlated with tree height and age, but due to the influence of site conditions on tree growth rate, DBH may not always be a good indicator of tree age.

### **Canopy cover**

Canopy cover provided by individual trees can be estimated by measuring the maximum canopy diameter and a second diameter at a right angle to the first. Canopy area can then be calculated using the formula for the area of an ellipse, i.e.,

$$\text{Area} = \pi * r1 * r2$$

where  $\pi = 3.14159$ , and  $r1$  and  $r2$  are the two radii (i.e., half the diameters). If tree canopies are symmetrical, a single diameter can be measured and the formula for the area of a circle ( $\pi * r * r$ ) is used. The total area covered by tree canopy can be divided by the area of the site to obtain percent canopy cover. This methodology works best for areas with nonoverlapping tree canopies, such as parking lots or other relatively open areas.

In areas with more complete or irregularly overlapping tree cover, other methods of estimating canopy cover are applicable. If data are being collected in individual fixed-area plots, ocular estimates of tree canopy cover may be adequate. A density scale (see the example under [Photogrammetry and remote sensing](#)) can be used to help calibrate different observers. Also, less error will be introduced if canopy is estimated in cover classes, such as the six-level scale discussed below.

Two similarly named instruments can also be used for measuring tree overstory canopy cover: the spherical densiometer and the densitometer. The two terms are sometimes interchanged, so either term may be used to describe either type of instrument. The spherical densiometer is used to measure canopy cover over a plot or other local area. An image of the canopy is reflected onto a gridded spherical mirror and the observer counts the number of points on the mirror that either contain or lack canopy cover. The number of points counted is then divided by the total number of points to calculate percentage. Several replicate measurements are needed to increase precision. Densiometer measurements are influenced by adjacent canopy height and tend to overestimate canopy cover because canopy is viewed at an increasingly oblique angle toward the edges of the mirror. Photos taken with a hemispheric or fisheye lens can be used in a similar fashion, except that canopy cover is evaluated on the images rather than directly in the field. Hemispheric photos have the same biases as spherical densiometer measurements. Bias can be reduced by using a smaller view angle (about a 10 degree arc), which reduces bias associated with oblique viewing angles.

The densitometer provides a point measure of canopy cover. The densitometer is a small sighting instrument with crosshairs and a bubble level that allows the observer to determine whether canopy is present directly overhead. This instrument is sometimes referred to as a moosehorn, and several variants exist. Since the densitometer measures canopy presence at a single point, multiple sample points must be measured to obtain a canopy cover estimate. Sample points can be spaced along a transects (see the example [Measurement of canopy cover at the edge of pavement \(CCEP\)](#)) or arranged in a grid pattern to obtain an estimate for a large area. Using a densitometer is directly analogous to using the [dot grid method](#) to estimate canopy cover from aerial imagery. Consequently, [sample size considerations](#) are the same as discussed for the dot grid method.

Evaluation example: [Measurement of Canopy Cover at the Edge of Pavement \(CCEP\)](#)

Evaluation example: [Evaluating parking lot shading](#)

### **Tree diameter (DBH)**

Tree trunk diameter at breast height (4.5 ft height if English units are used) is one of the most commonly measured tree size statistics. However, tree form, ground slope, and other factors can complicate this measurement. We have developed a [Simplified guide to measuring DBH](#) that discusses a number of these common issues.

## Tree height

There are many methods for measuring tree height. Tree height can be measured directly with a calibrated measuring pole or indirectly through trigonometric relationships by using a clinometer or a similar device. Many websites describe methods for measuring tree height. Five easy methods for measuring tree height are given at the Woodland Restoration for Wisconsin Schools, Earth Partnership for Schools Program, University of Wisconsin-Madison Arboretum website [http://wiscinfo.doit.wisc.edu/arboretum/woodland/tree\\_height.htm](http://wiscinfo.doit.wisc.edu/arboretum/woodland/tree_height.htm).

## Tree condition/health

Evaluating tree condition is always a subjective enterprise, because such evaluations rely on visual assessments made by observers. The simplest scales rate the condition of living trees as good, fair, or poor. If more detail is needed, various aspects of tree condition are independently rated. Certain ratings (e.g., canopy thinning or live crown ratio, decay ratings) provide information about chronic health problems, whereas others (e.g., current season foliar symptoms) reflect recent health impacts. Quantitative rating scales (discussed below) can simplify assessments and reduce variability between different observers.

The USDA Forest Service Inventory and Analysis program has developed detailed standardized methods for rating tree condition and many other tree and plot factors. Illustrated manuals describing these methods in detail are available online at <http://fia.fs.fed.us/library.htm#Manuals>. Detailed scales for evaluating tree health and condition developed by The Urban Forests Centre at the Faculty of Forestry, University of Toronto, which are part of the Neighbourwoods inventory program, are available on the Internet at <http://www.forestry.utoronto.ca/urban/community/neighbourwoods.html>. The Neighbourwoods program is designed to minimize bias among different surveyors. This website includes scales and in some cases photographs for evaluating the following conditions:

- unbalanced crown
- weak or yellowing foliage
- defoliation
- dead or broken branches
- poor branch attachment
- lean
- pruning scars
- basal/trunk scars
- conks
- rot/cavity
- cracks
- girdling roots
- exposed surface roots
- trenching/grade change

## Hazard trees

Some of the factors listed above relate directly to a tree's hazard rating. An illustrated guide to hazardous trees is available online at the USDA Forest Service St. Paul Field Office web site [http://www.na.fs.fed.us/spfo/pubs/howtos/ht\\_haz/ht\\_haz.htm](http://www.na.fs.fed.us/spfo/pubs/howtos/ht_haz/ht_haz.htm). ISA publishes a widely-used guide titled "A Photographic Guide to The Evaluation of Hazard Trees in Urban Areas, 2nd edition". This publication can be ordered from ISA at <http://www.isa-arbor.com/catalog/pubs2.html>

## Proximity to infrastructure and hardscape damage

Conflicts that develop between trees and infrastructure are often evaluated in ground surveys. The proximity of overhead wires, buildings or other structures, other trees, traffic signs, and sidewalks and curbs can all require management actions to maintain public health and safety or tree health. Distances between trees and various hardscape elements can be assessed by measuring distances directly (using tape measures, distance measuring wheels, or rangefinders) or can be rated qualitatively based on visual inspection (not a problem, potential/future problem, current problem). If damage or conflicts are present, the nature and extent of the problem can also be noted and prioritized for corrective action.

## Rating scales

Various types of tree assessments do not lend themselves to direct measurement but can be estimated visually. For instance canopy dieback, an important tree health parameter is difficult to measure directly but the percentage of the canopy affected by dieback can be estimated by a trained observer. Other assessments, such as canopy cover, can be assessed using reasonably precise methods, but the amount of time and effort required may not be justified based on the use of the data. In such cases, ocular estimates may be used even though more precise methods are available.

As noted above, visual rating scales can be developed for many of the assessments that are made in ground surveys. Qualitative rating scales can be quite objective if only the presence or absence of a characteristic is noted (e.g., presence/absence of leafy mistletoe). Subjective qualitative scales (e.g., rating mistletoe infection as light, moderate, or heavy) are also commonly used, but it can be difficult to obtain consistent ratings from multiple observers when subjective scales are used. However, such scales can be useful if qualitative categories are augmented with more quantitative explanations (e.g., light mistletoe rating= less than  $n$  infections). Photo keys that illustrate different qualitative rating classes can also help make qualitative ratings more objective and repeatable among different evaluators.

Quantitative rating scales are also commonly used. Scales are used to simplify the estimation of quantities such as counts or percents. Different types of scales may be appropriate for different types of ratings. For instance, when estimating percent cover in small circular area (e.g., within the dripline of a tree), a scale using 25% increments (0-25%, 26-50%, etc.) is typically easy to use and can be rated consistently. For estimating plot canopy cover, canopy dieback, or other quantities that can vary across a wide percentage range, the following 0 to 6 scale is useful:

Rating	Percentage range
0	none / not present
1	more than 0 but less than 2.5%
2	2.5% to less than 20%
3	20% to less than 50%

4	50% to less than 80%
5	80% to less than 97.5%
6	97.5% or more

Note that the classes in this scale are not uniform in size and are largest near 50% and smaller near 0 and 100%. Various studies have shown that observers are able to estimate percentages (such as percent cover) that are close to 0 or 100% with greater accuracy than they can estimate percentages near 50%. This makes sense intuitively. For instance, it is easier to distinguish between 2% and 12% cover than it is to distinguish between 45% and 55% cover, even though the absolute difference is 10% cover in either case. The scale above is similar to the [Daubenmire \(1959\)](#) scale except that the class edges have been modified so that the midpoints of the scale increments are equally spaced in an arcsine transformed scale. Percentage data is typically binomially distributed and the arcsine transformation (arcsine of the square root of the percentage expressed as a decimal) is used before this type of data is analyzed using standard parametric statistical tests. By using a pre-transformed scale ([Little and Hills 1972](#)), ratings can be statistically analyzed without further transformation.

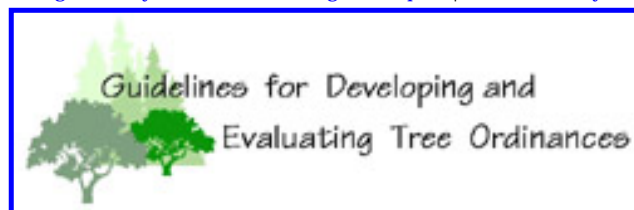

## Measurement of canopy cover at edge of pavement (CCEP)

---

Street tree canopy is especially problematic to assess because of differences that exist in street widths and configurations. After reviewing existing methods and experimenting with various methods, we recommend **canopy cover at the edge of pavement (CCEP)** as a standard for assessing street tree canopy. CCEP can be measured on almost all types of roads either from [aerial imagery](#) or by [ground survey](#). Furthermore, CCEP values are related to the amount of shading that streets receive, and the "canopied" effect that is obtained when trees arch over streets. In the two photos below, the street on the left has a low CCEP value whereas the street at the right has a high CCEP value. Both streets are in Vacaville, CA.



### Measuring CCEP from aerial images

Variations of the [line intercept method](#) are used to measure CCEP from aerial images. Using the hybrid line/point method, the evaluator lines up a single row of dots or a finely divided ruler along the visible edge of the pavement. The evaluator counts the number of dots or ruler divisions that fall on tree crowns and the total number of dots in the sampled segment. Percent CCEP is then calculated as:

$$\% \text{ canopy cover} = 100 \times (\text{points falling on tree canopy} / \text{total number of points along sampled lines})$$

While this method is easiest to apply on relatively straight sections of road, it is possible to apply the method on moderately curved roads by using a flexible plastic rule held on edge.

On very curved roads and those with very low or high canopy cover, it may be more efficient to use the standard line intercept method. In this method, the lengths of all tree canopies that intersect the line of the edge of pavement are



measured with a ruler, planimeter, or digitizer. Percent CCEP would be calculated as for the line intercept method, i.e.,

$$\% \text{ canopy cover} = 100 \times (\text{length covered by tree canopy} / \text{total length of sample})$$

## Measuring CCEP via ground survey

CCEP can also be readily evaluated by using a foot survey. To estimate CCEP in a foot survey, the evaluator walks along the edge of the pavement. At evenly spaced points, e.g., every 3 steps, the evaluator notes whether canopy is present directly over the point at the edge of the pavement. Hand tally counters can be used to keep track of the total number of sample points and the number of sample points with tree canopy overhead. A length of 1/2 inch diameter PVC pipe, lightweight measuring pole, densitometer (a small instrument with a level that allows one to sight a point directly overhead), or similar tool can be used to help project a line vertically from the edge of pavement upward to increase the accuracy of the evaluation. The percent CCEP is calculated using the following formula:

$$\% \text{ CCEP} = 100 \times (\text{points with canopy cover} / \text{total number of points})$$

One advantage of measuring CCEP as part of a ground survey is that it allows one to examine correlations between CCEP and other tree or site characteristics. The evaluator can collect data on site or tree characteristics at the same time that canopy is being assessed. The level of CCEP can be affected by tree species selection, tree age, planting position, and pruning practices, and it may be of use to know which factors are the most important in your community.

### Evaluation example: *Street tree canopy measured using two methods*

We measured percent canopy cover at edge of pavement (CCEP) in two different subdivisions in Vacaville, California. One subdivision was constructed around 1950 and the other was completed in 1975. We assessed CCEP from 1:2,400 aerial photography taken in 1973 and 1980, 1:1,200 aerial photography taken in 1978, and by ground surveys in 1990 and 2001 along typical residential streets in these areas. Street segments analyzed were about 0.5 mile in length. Percent CCEP values (averaged for both sides of each street) for the different evaluation dates are shown below. It should be noted that even though several curb/sidewalk configurations were present along different portions of the first site (no sidewalk, sidewalk adjacent to curb, treelawn between curb and sidewalk), they did not affect the determination of CCEP.

#### **Subdivision completed in 1950 (Peach Tree Avenue)** study area 0.45 mile long

<b>Year</b>	<b>Years since development</b>	<b>CCEP</b>
1973	23	33%
1978	28	37%
1980	30	37%
1990	40	34%

2001	51	30%
------	----	-----

**Subdivision completed in 1975 (Andrea Drive; left photo at top of page)**  
study area 0.56 mile long

<b>Year</b>	<b>Years since development</b>	<b>CCEP</b>
1978	3	0%
1990	15	8%
2001	26	20%

These data reflect changes in street tree selection and planting practices between 1950 and 1975 as well as the effects of tree maintenance practices. Part of Peach Tree Avenue was planted by the developer with Modesto ash (*Fraxinus velutina* 'Modesto') street trees. These are fast-growing trees that produce a large crown. Trees were planted relatively close to the sidewalk, and consequently a high CCEP developed in these areas relatively quickly. Other portions of the same street were planted on an ad hoc basis by homeowners, and CCEP levels in these areas were relatively low. Canopy cover on Peach Tree peaked about 30 years after development as the Modesto Ash trees reached mature size. Subsequently, poor maintenance practices by many homeowners, particularly severe topping, have led to a decline in tree condition and CCEP. Between 1990 and 2001, a number of mature trees were removed, causing further reductions in CCEP. Notably, CCEP on the south side of Peach Tree Ave. has dropped from 34% in 1990 to 25% in 2001.

In the Andrea Drive subdivision, developers provided a tree for each house to be planted by the owners. Not all owners complied and/or some plantings were unsuccessful, and as a result, street tree canopy is quite sporadic. Many of the trees were species that develop only medium-sized crowns. Because many of the trees were also planted in the centers of the front yards rather than near the street, most tree crowns barely reach the edge of pavement even though the trees are approaching their mature spread. Thus, while CCEP has increased from 8% in 1990 to 20% in 2001, it is unlikely to increase much further unless additional trees are planted. CCEP 26 years after development on Andrea Drive is well below that seen 23 years after development on Peach Tree Avenue.

Street tree canopy provides a variety of benefits, including reductions in the urban heat island effect and resultant energy conservation, longer pavement life, "traffic calming", reduced hydrocarbon emissions from cars parked along streets, and enhanced property values. If a community has the objective of developing and maintaining street tree canopy through comprehensive planning and appropriate ordinances, evaluations of CCEP help provide the needed information on the status of street tree canopy and the consequences of past management actions.



## Evaluating parking lot shading

---

Shade provided by trees in parking lots reduces excessive heat buildup which can adversely affect the local microclimate and air quality ([Center for Urban Forest Research 2001a](#)). Recognizing this fact, many cities have adopted ordinances that require set amounts of tree planting or shading in parking lots (see [provision 25](#)). Parking lot shade ordinances lend themselves readily to retrospective analysis to determine whether the goals of the ordinance are indeed being met. Greg McPherson and coworkers at the USDA Forest Service Pacific Southwest Research Station [Center for Urban Forest Research](#) evaluated shade in parking lots in Davis and Sacramento, CA. Like many other California communities, these cities have ordinances that require parking lots to be landscaped so that 50% of paved area is shaded 15 years after development of the lot.

In Davis, five parking lots were selected for evaluation. Ground surveys were undertaken to identify tree species, size, condition, and management needs. Tree canopy cover in these lots was evaluated via remote sensing techniques. Aerial color infrared photographs were taken of the parking lots. The researchers then used image analysis and GIS software to determine the percentage of paved area shaded by existing tree canopy. An overlay was created based on the original landscape plans to show the planned mature size of trees (below).

## Tree Cover Survey (Davis High School / Community Center Parking Lot, Davis, California)

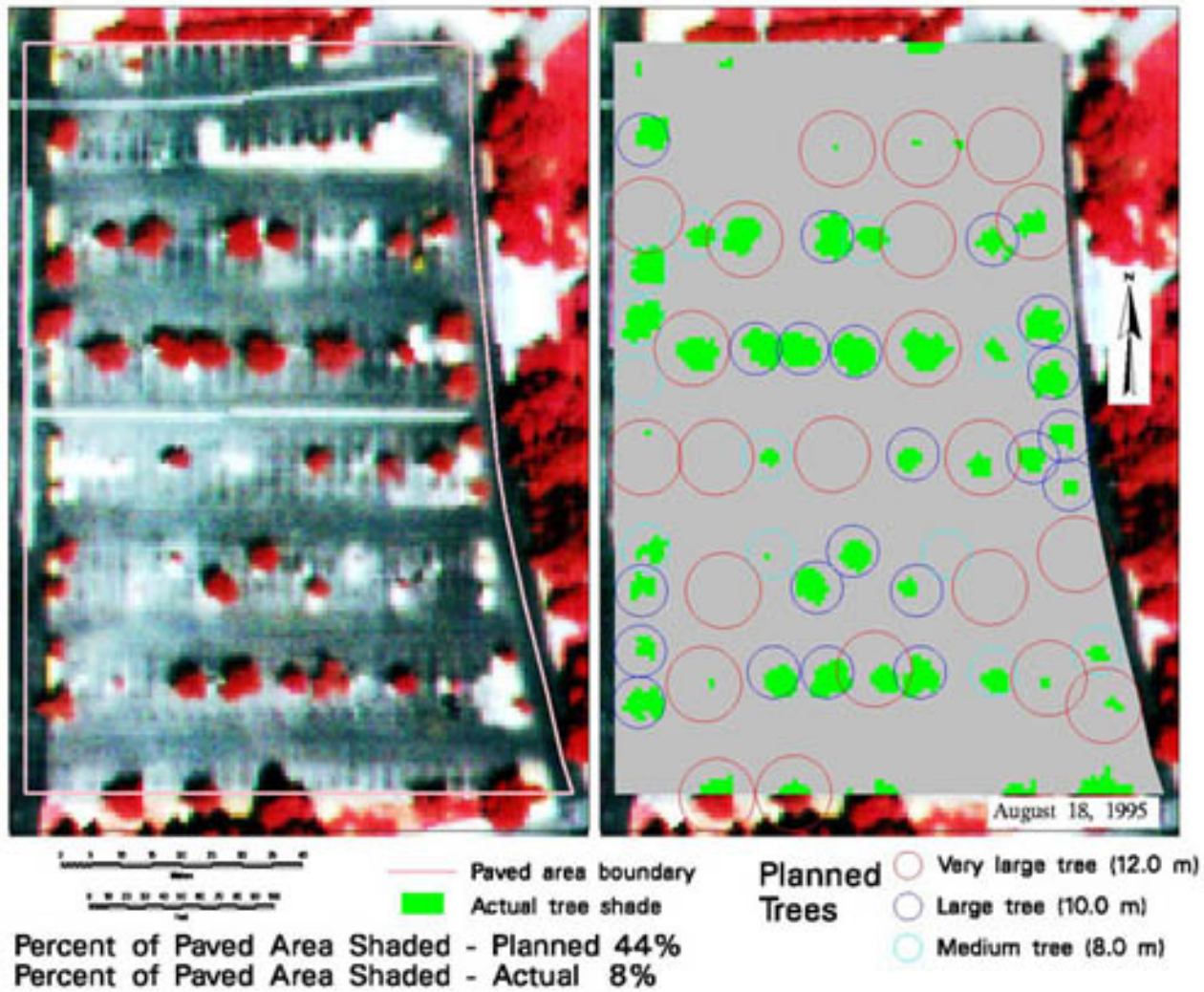

Image courtesy of USDA Forest Service, Pacific Southwest Research Station, [Center for Urban Forest Research](#).

The researchers found that current shade coverage ranged from 8 to 45% of the paved area of the lots. Furthermore, they found that the original designs showed projected pavement shading of 18% to 47% by 15 years after development, all less than the ordinance standard of 50% shading. The Davis ordinance, which was adopted in 1979, was updated in 1997 based on information from the parking lot shade survey.

A similar analysis of 15 parking lots in Sacramento, CA ([McPherson submitted](#)) was made with the help of volunteers from the Sacramento Tree Foundation. Using ground surveys only, volunteers recorded the following data:

- tree species
- DBH
- average crown diameter (determined by measuring canopy two radii at 90 degrees to each other to the nearest 0.5 meter by tape)
- the percentage of crown that shades parking lot pavement to the nearest 25% excluding overlapping shade

- management needs
- vacant planting sites.

In addition, the researchers used original site plans on file with the Planning Department to calculate the total paved area in each lot. Shading provided by each tree was estimated assuming that crowns were circular in outline. For the 10 lots in which the trees were less than 15 years old (range 1-14 years), the researchers used empirical data on tree spread at different ages collected from the nearby city of Modesto to estimate crown diameter after 15 years. Since much of this data was based on street trees growing in residential yards, it probably overestimates parking lot tree growth.

This survey found that the ordinance, enacted in 1983, was only partially effective in meeting its goals. One of the lots over 15 years old actually exceeded the shading standard (55%), and another was close to the standard (47%). However, projected tree shade 15 years after development averaged only 21% overall. The analysis also showed that tree shading was generally lower in retail business lots than in office or apartment parking lots.

Researchers found that the following factors contributed to the failure of parking lots to meet shade standards. Several of these factors are also likely to contribute to failure of other types of parking lot planting ordinances.

- Trees shown on plans were not planted or else were removed shortly after planting. This was a particular problem near store fronts where business owners feared trees would block their signs.
- Tree species planted in lots were not those shown on plans.
- Crown diameters listed for tree species in the supporting regulations were larger than trees would actually attain under parking lot conditions.
- There was no crown spread data in the supporting planning regulations for some of the species commonly planted in parking lots.
- Submitted parking lot plans used the wrong crown spreads for the trees in the plans and the errors were not caught by the Planning Department.
- Tree shade was overestimated in cases where overlapping shade from adjacent trees was counted twice.

Trees growing in parking lots are often stunted because soil compaction and impermeable pavement limits the amount of rootable soil volume available and because temperature and soil moisture regimes in parking lot islands are often unfavorable for tree growth. In addition, sometimes soil is treated with chemicals during the construction process (e.g., high amounts of lime) that may render it unfavorable for plant growth. By measuring crown spread of trees in Sacramento parking lots, researchers were able to determine the likely crown spread that various tree species could attain when grown in parking lots. Tree crown projection areas (i.e., area of shade provided by trees) after 15 years, as measured by McPherson's group, were considerably less than those listed in the supporting regulations.

McPherson also conducted an economic analysis to calculate both the loss in benefit value associated with the lack of compliance with the ordinance (estimated at about \$2.2 million per year citywide) as well as the likely costs of various remedial actions. In addition to suggestions for improving the parking lot shading ordinance, this analysis provided insight into elements of site planning and parking lot design that could be modified to reduce total amounts of area devoted to parking and increase shading of paved areas ([McPherson submitted](#)).

[Return to Ground Survey](#)



## Simplified guide to measuring DBH

---

In the US, tree diameter is usually measured at 4.5 ft (137 cm) above ground level. Measurement at this height is referred to as diameter at breast height or DBH. DBH can be measured with a specially calibrated tape measure called a diameter tape (d-tape) available from arborist or forestry supply dealers. In a tree with a clear gradually tapering trunk, measuring DBH is straightforward, but there are a number of circumstances in which questions arise about how to measure DBH. The following guide can be used to solve some of the more common complications. In the guide below we have generally used the simplest methods we found recommended in other sources. Other guides with illustrations can be found at:

The Tree Register of the British Isles - <http://www.tree-register.org/tree-conservation.htm>

Canada's National Forest Health Monitoring Plot Network Manual on Plot Establishment and Monitoring (Revised) from the Environment Canada Ecological Monitoring and Assessment Network (EMAN) site - <http://eqb-dqe.cciw.ca/eman/reports/publications/arnews/part23.html#f5>

USDA Forest Service's Forest Inventory and Analysis (FIA) program manual - <http://fia.fs.fed.us/library.htm#Manuals> (rules for determining DBH heights for forked trees become very complicated in this manual)

**1. The tree tapers in such a way that the diameter at a point below 4.5 ft is actually smaller than the diameter at 4.5 ft.**

Measure diameter at the smallest point and record the height at which diameter was measured on the data sheet.

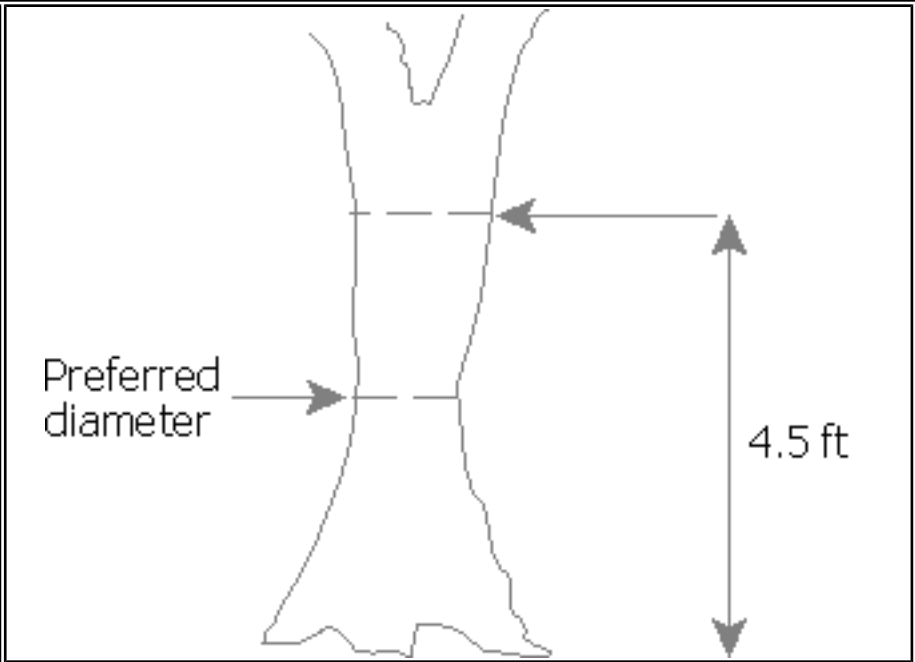

**2. Tree has branches or bumps which interfere with DBH measurement.**

Measure DBH below the branch or bump. Some references say to measure a foot below the branching point, which assumes this point is the smallest diameter of the trunk below 4.5 ft. Record the height DBH is measured at.

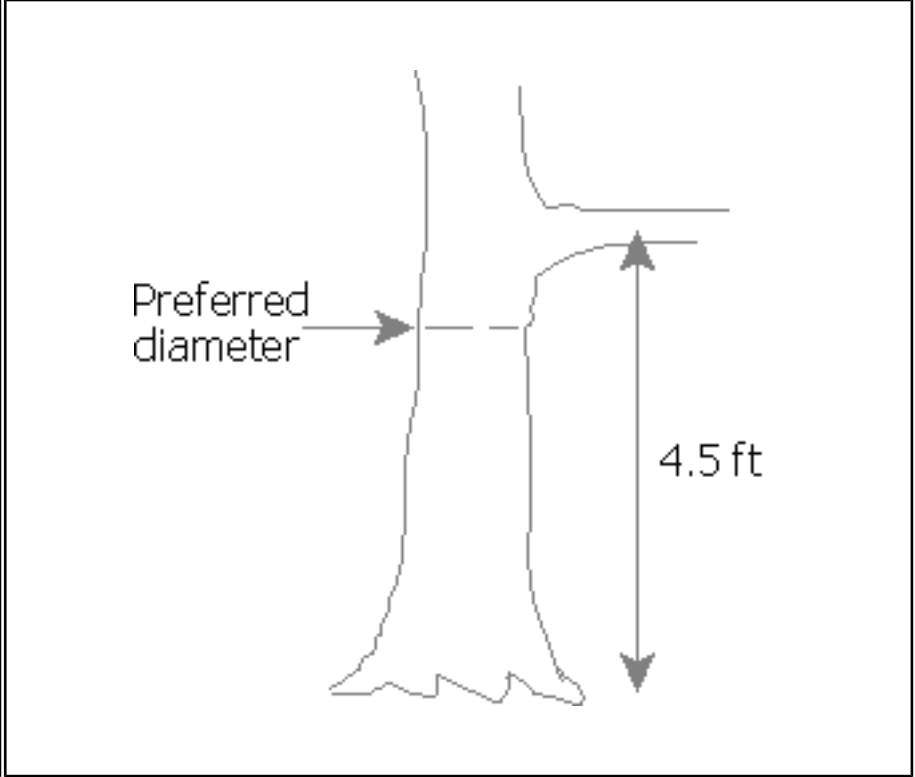

### 3. Vertically growing tree is on a slope.

There are several commonly accepted ways to find the DBH height. Probably the easiest method is to measure diameter 4.5 ft from the ground on the upper side of the slope. This method is used by the US Forest Service. Some references (e.g., International Society of Arboriculture's Tree Appraisal Manual) say to measure 4.5 ft from the midpoint of the trunk along the slope. However, finding the location of the trunk midpoint is probably subject to more error than finding the upper side of the trunk, so the USFS method is likely to be more repeatable than the ISA method.

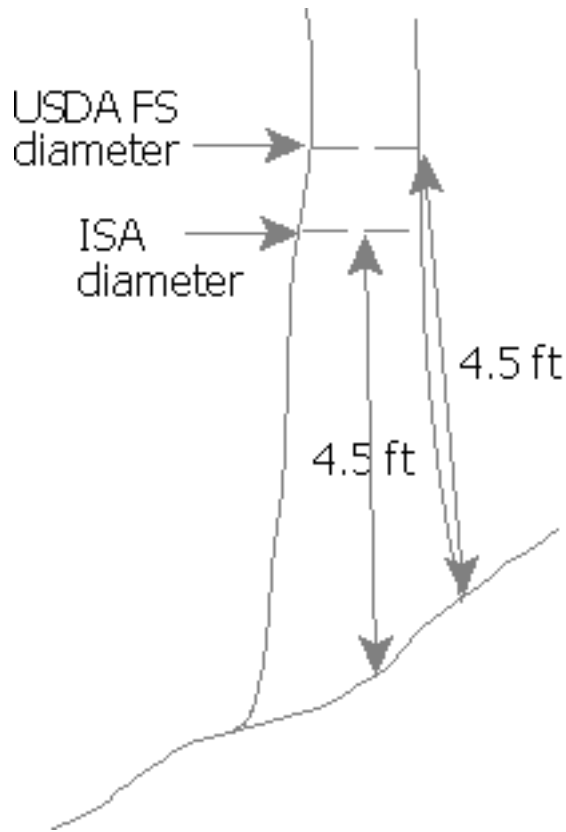



**4. Tree leans.**  
 There are several commonly accepted ways to find the DBH height. The US Forest Service measures 4.5 ft up the stem in the direction of the lean. Some references (e.g., ISA) say to measure 4.5 ft from the midpoint of the lean. As noted under 3 above, the USFS method is probably less prone to error and more readily repeatable by different observers.

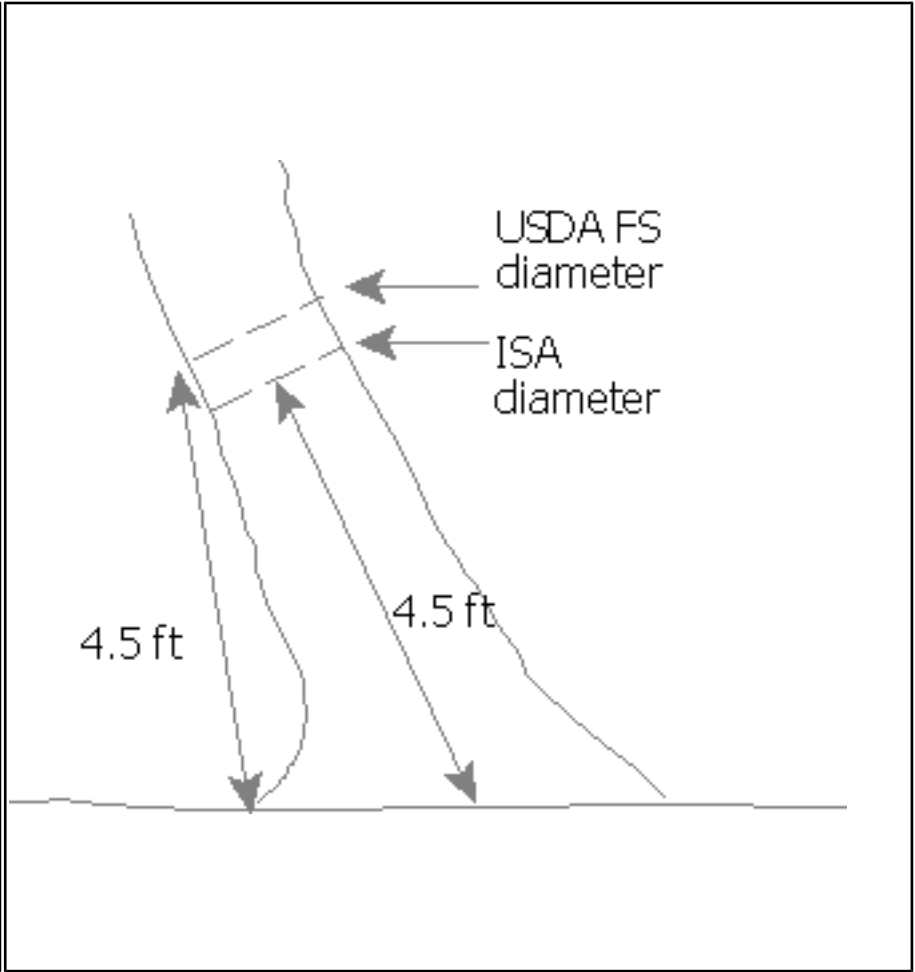

**5. Tree forks below DBH or near DBH.**  
 The measurement is recorded at the narrowest part of the main stem below the fork. The height of the DBH measurement and the fork should be noted (e.g., 3 ft diameter @ 2 ft [Forks @ 4 ft]).

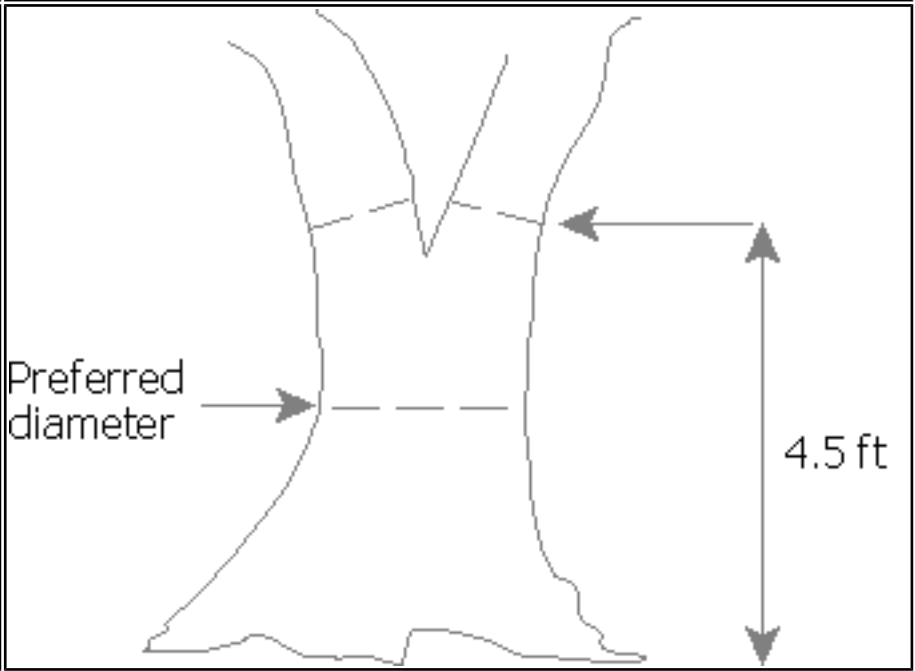

**6. Tree splits into several trunks close to ground level.** Measure DBH of each trunk separately, using the principals shown in categories 1-5 above. The DBH for the tree is found by taking the square root of the sum of all squared stem DBHs.

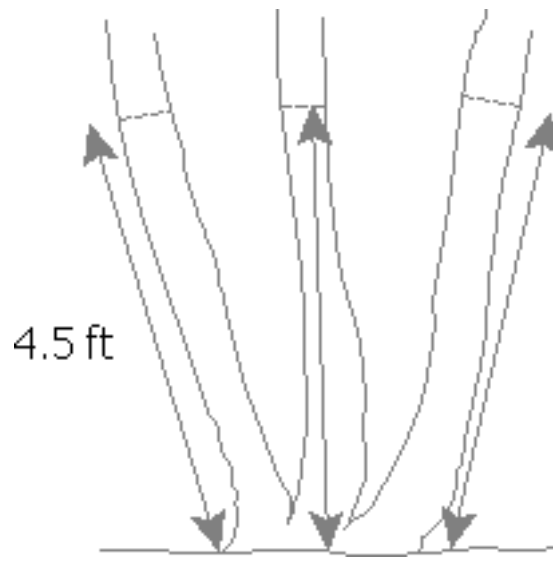

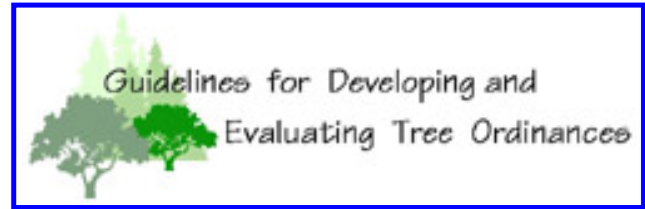

## Photo points

---

### Uses:

Monitoring the growth, condition, and survival of individual trees or groups of trees over extended time intervals.

### Materials needed:

- -Suitable record book or data file for keeping photo point information over many years.

#### For ground-level plots:

- A 35 mm camera and color print or slide film are probably the most versatile. A short focal length lens (about 35 to 70 mm) is preferred. Images from very wide-angle lenses (shorter focal lengths) may have too much distortion, and telephoto lenses (longer focal lengths) may not have a wide enough field of view to be practical.
- Tripod to ensure that serial photographs are taken from the same elevation and angle. A small bubble level and a protractor attached to the tripod head can be used to duplicate photo angles more accurately.
- A magnetic compass to align the angle of the camera in the horizontal plane.
- Maps to note the location of the camera and the photo plot.
- Permanent survey markers, although not strictly necessary, may be useful for marking the exact camera location.

#### For aerial plots:

- Aerial photographs of a given area taken over a period of years. Photographs should be about 1:5,000 or larger scale. Preferably all photographs in the series should be taken or printed at the same scale, and taken at the same time of year.

### Notes:

A *photo point* is a location from which a specific field of view can be relocated and rephotographed repeatedly. Changes in the tree population at a given site are easily seen by examining a series of photographs taken from a photo point over a period of years. If images are digitized, graphics software can be used to scale photos to match and even produce animated "time lapse" presentations.

## Ground level photo point

There are two major considerations in establishing an effective photo point. First, trees and other features which are to be documented should be clearly visible at the time the original photo is taken as well as in future photographs. Try to situate the camera well away from vegetation that might subsequently block the view. Also, avoid views across vacant lots or areas where subsequent construction would interfere with the image. Perspective should also be considered in composing photos. For example, empty planting spaces along a street are easier to see in a view that looks across rather than down a street.

Second, it is desirable to duplicate the original camera view in later photographs as precisely as possible. The best match will be obtained if the camera location and angle, and the time of day and time of year are duplicated in later photographs. Take careful notes at the time that the original photo is taken. The location of the camera can be referenced to permanent landmarks, such as property lines, intersections, fire hydrants, and the like. A survey marker or other permanent monument may be installed at the camera location to facilitate relocation. A compass bearing should be taken to establish the direction of the photo in the horizontal plane (be sure to note whether the bearing is corrected for declination). Information about the height of the camera and its angle above or below level should be noted. The type of lens, focal length setting (if a zoom lens is used), date, and photographer should also be noted for future reference.

In some cases, historical photographs may already be available, but the actual location of the camera is unknown. With a copy of the photo in hand, it is often possible to establish a new photo point that closely matches the original angle. This may be easier to accomplish using a camera with a zoom lens. Once the new point is established, the data described above for new points should be noted so that subsequent photos can be taken from the same point. Ground level photo points are limited by the area that can be effectively shown in each photo. They are likely to be less effective for dense stands of trees and areas with many tall buildings. In some cases, these limitations can be overcome by getting a higher vantage point, such as from the top of a hill or building. In other situations, aerial photo points may be necessary to allow adequate monitoring.

One application of this technique would be for monitoring the effectiveness of tree protection and preservation during development or new construction. Well-situated photographs taken before, during, and after construction can be used to document and monitor both short and long-term impacts. Trees damaged during construction and development may not show serious symptoms until five or ten years later. Strategically situated photo points can clearly show whether protected trees have subsequently declined or been removed.



Pope Valley, CA 1989.



Pope Valley, CA 1995. Note hillside clearing, decline of large valley oaks on valley floor at left, and growth of oak seedlings protected from grazing.

## Aerial photo points

An aerial photo point is simply a variation of the use of aerial photography described under [Photogrammetry and remote sensing techniques](#). Permanent plots are established based on easily recognizable features such as roads, buildings, utility corridors, or landforms, so that the same area can be compared in successive photographs. Photographs should be printed at the same scale to facilitate direct comparisons. Transparent overlays can then be used to pinpoint the location of specific trees in different photographs.



## Record keeping and analysis

---

### Uses:

Planning for future needs and evaluating various aspects of urban forest management.

### Materials needed:

-Record keeping materials, such as files, record books, maps, and computers with database and/or geographic information system (GIS) software. Actual materials will vary with the types of records kept.

-For tree inventories especially, specialized computer software is recommended.

### Notes:

Record keeping systems may be simple or intricate. Tree programs with a few limited goals will require a limited number of records to evaluate their success. On the other hand, comprehensive tree programs may need to keep more detailed records, and a more extensive record management system will be needed.

Comprehensive tree inventory systems, as discussed below, can provide a wealth of information about the urban forest and municipal tree care operations. However, additional records are normally required to cover aspects of the tree management program such as long-term planning, public education, ordinance enforcement, and program administration. For example, tabulations of tree-related permits, ordinance violations, and enforcement actions may be needed to assess the implementation of certain tree ordinance provisions.

## Geographic Information Systems (GIS)

Trees have fixed locations and exert many of their effects, such as shading, on a specific geographic area. Tree growth is also influenced by local site conditions. If tree resource data are linked to the geographic coordinates of the tree or stand of trees they describe, tree information can be displayed and analyzed spatially. Geographic information system (GIS) software is therefore a logical choice for storing and manipulating tree resource data.

Geographic information systems are computer systems capable of assembling, storing, manipulating, and displaying data that are identified according to their locations. Such data may be referred to as geographically

referenced information or geospatial data. A GIS can be thought of as an electronic map that includes data associated with specific points, lines, polygons, and/or pixels that represent fixed geographic locations. Numerous websites describe GIS and its capabilities. A few general sites include:

- US Geological Survey GIS page: <http://www.usgs.gov/research/gis/title.html>
- US Census Bureau GIS FAQ page: <http://www.census.gov/geo/www/faq-index.html>

GIS software is available for most common computer operating systems and hardware platforms. Several websites that list commercially available GIS software vendors are listed below:

- University of Colorado at Boulder Virtual Geography Dept. - <http://www.colorado.edu/geography/virtdept/resources/vendors/vendors.htm>
- University of Florida GeoPlan Center - <http://www.geoplan.ufl.edu/software.html>
- University of Oregon Map and Aerial Photography Library - <http://libweb.uoregon.edu/map/GIS/giscompanies.htm>
- University of Minnesota John R. Borchert Map Library - [http://www-map.lib.umn.edu/GIS\\_companies.html](http://www-map.lib.umn.edu/GIS_companies.html)
- Geospatial Solutions (a trade publication) resources page - <http://www.geoinfosystems.com/resource.htm>

Many commercial GIS vendors distribute free demonstration versions of their software for evaluation. Some public domain GIS software is also available for free download. GRASS GIS (Geographic Resources Analysis Support System), a multiplatform, open source GIS, can be downloaded from Baylor University and various mirror sites (see <http://www.baylor.edu/grass/>).

## **Evaluation example: *Creating a forest/tree GIS***

To show how Dane County's (Wisconsin) forests and individual trees could be mapped and inventoried using a geographic information system (GIS), the Land Information and Computer Graphics Facility, University of Wisconsin-Madison conducted a pilot project for the Dane County Tree Board. The report at <http://www.forests.org/danetree/forestgis.htm> provides the results and lessons of this project.

## Evaluation example: CITYgreen software for ArcView GIS

### Tree inventory systems

Tree inventory software is commonly used to store information about intensively-managed trees, especially those along streets and in parks. In most communities, only trees managed by the city or county are included in tree inventories. These may include both trees on public land and on private property along the public rights-of-way (ROW). The most basic tree inventories are simply lists of the locations and descriptions of individual trees. More advanced inventories include information on site characteristics, past maintenance, and anticipated maintenance needs for each tree. Complete inventories provide a direct means for assessing the relationship between trees, planting locations, and maintenance expenditures. The types of information included in the inventory should reflect the goals of the ordinance and the overall tree management strategy. Some of the variables which may be evaluated are as follows:

**Trees:** species, diameter, height, canopy spread, age or age estimate, remaining life expectancy, condition with respect to health and structural integrity (hazard), value, historical significance;

**Sites:** location coded by street address, distance along street, or actual coordinates (e.g., latitude and longitude), planting site specifications (e.g., 3 ft tree well, 4 ft parkway, in lawn 7 ft from sidewalk), proximity to above- or below-ground utilities, potential for replanting if empty, soil type, known soil limitations (e.g., persistent soil-borne diseases such as *Armillaria*, high salt or boron levels, excessive compaction, low water-holding capacity, poor drainage);

**Cultural practices:** past cultural inputs by date of action including planting, fertilization, pruning, cabling, pest control, removal; presence of maintenance problems by date observed, including sidewalk damage, limb breakage, severe disease or insect attack; resident inquiries or complaints; projected maintenance needs and priority;

**Costs:** materials costs, equipment use, and personnel hours incurred for each cultural operation by date.

Data for tree inventories may be compiled from one or more sources. [Ground survey](#) techniques are typically used to compile most of the basic tree and site attributes. Site information may be available from an existing municipal GIS or plans. Job records are the source of most data related to cultural practices and their associated costs. Most tree inventory software is designed to allow for direct entry of work records, tree data, and site information into the program and provide a central database that permits the tree program manager to view all of the pertinent information about a tree when scheduling maintenance. Various vendors produce tree inventory software, including software that are extensions of popular GIS programs such as ArcView®. Using commercial software can reduce the amount of time required to develop custom programs or GIS applications, but may not provide the same degree of flexibility and integration with existing software that



might be obtained by having custom software developed in-house or through a contractor.

### **Additional resources:**

Olig, G. A.; Miller, R. W. 1997 A Guide to Street Tree Inventory Software. Online at <http://www.na.fs.fed.us/spfo/pubs/uf/streettree/toc.htm>. This review is several years old. Many of the programs reviewed are still available, although vendors should be contacted for information on their most current releases.

The [Community Forestry Education Project](#) (Rochester, NY) provides free spreadsheet (MS Excel) and database (MS Access) street tree inventory templates. These templates are not GIS-based, but by adding geographic coordinates for each tree to the template, a GIS-ready database could be constructed.

### **Evaluation example: *Street tree inventory as part of a citywide GIS***

An example of a street tree inventory that is integrated with a municipal GIS can be accessed interactively online at the [City of Ithaca \(NY\) GIS website](#). The City of Ithaca started developing its GIS mapping effort in 1990 using base map information derived from photogrammetrically produced maps. Many of the GIS layers are available to the public via a standard web browser. In addition to street trees, the GIS layers available on the Internet server include buildings, property lines, utilities, sidewalks, and boundaries of districts and other areas. The Internet interface (which uses MapInfo's MapXSite software) allows users to zoom and pan on a map or to locate sites by address or tax parcel number. To view street trees in the GIS, check to see that the "Trees" layer is turned on and zoom in 0.25 miles or less. If you set the "click on the map" option to "get info", you can view data for any individual tree by clicking on it and then clicking on the tree common name. Only a portion of the data stored in the GIS is made available to public users; city staff and other authorized users have access to additional information and data query functions.

## Evaluation example: *Street tree management*

Although GIS greatly enhances the options for manipulating and presenting spatial data, simpler databases can also provide the information needed for urban forest analyses. The City of Cypress, California, provides a classic example of how tree records can be used to evaluate and adjust tree management practices. The city implemented a computerized tree inventory system in 1971 that included detailed work records for each tree. In 1981, they compiled data from the inventory database to determine which trees and planting situations were causing the most damage to concrete curbs and sidewalks. This information was used to adjust the tree management program in several ways. Improved tree selection guidelines were developed to obtain better compatibility between the trees and planting sites. The data were also used to predict locations where future damage was most likely to occur. These areas were targeted for a phased removal program, in order to head off future problems without an abrupt removal of the entire street tree canopy. Finally, a tree ordinance was adopted that provided the authorization needed for the city to control street tree planting, maintenance, and removal.

## Inventorizing regulated private trees

As we have noted elsewhere, most trees within communities are on private properties outside of the public ROW, so inventories of publicly-managed trees include only a small portion of the community forest. Although trees on private properties are not commonly included in city tree inventories, many cities already collect data on certain classes of trees in connection with planning and permitting processes. Virtually all site development plans include a landscape plan that includes both existing trees that are retained on site as well as new trees that are planted as a condition of plan approval. Tree attributes such as species and size are commonly available from these plans, and more detailed information may be available if a tree survey is required in the development process. If these data were compiled in a master inventory, preferably GIS-based, it would provide a powerful tool for monitoring ordinance compliance and efficacy. [Historic or heritage trees](#) could also be included in such an inventory if the protection of such trees is a local priority.

Compilation of this tree information into a GIS may require an additional step beyond current practices. However, if the city or county requires applicants to provide geospatial coordinates and attributes for trees shown on plans, adding this data to an existing GIS would require relatively little additional effort. A consolidated inventory of these trees would allow the local government to track the fate of trees that have been planted or conserved as a result of local ordinances or regulations. An inventory of regulated trees could be used to more easily determine:

- whether current property owners are maintaining trees that were required as conditions of approval on original site plans;

- whether required replacement plantings are surviving;
- whether intended or approved species are being used when trees are replaced;
- long term survival of retained trees that have been subjected to construction-related damage;
- whether a request for tree removal affects a tree that was originally conserved or planted to comply with the tree ordinance or permit approval requirements.

Many, if not most, communities require tree planting or retention as a condition of approving various projects. However, if the long-term results of these regulatory practices cannot be assessed readily, it will be difficult to determine whether the regulations are really accomplishing their goals. By consolidating and organizing data on regulated trees that is already being collected, local governments would be able to assess the impacts of their tree regulations more easily, and could use this information to improve enforcement and/or develop better regulations.



## Evaluation example: *CITYgreen software for ArcView GIS*

---

One [goal](#) of a community's urban forest management strategy might be to maximize the benefits that trees provide, such as air pollutant removal, stormwater runoff reduction, and/or energy conservation. If this is the case, quantification of tree-related benefits might be useful for assessing current conditions or evaluating the results of ordinances or other management actions. Various researchers have developed formulas that can be used to estimate the magnitude of benefits related to tree canopy. Economic values associated with these ecosystem services can be calculated in some cases. For instance, energy savings can be converted into economic terms by multiplying the difference in energy usage by local utility rates. However, a complete analysis should also account for the value associated with avoided costs, such as avoided air pollution emissions associated with reduced power consumption. Researchers continue to develop and refine the formulas and parameters used to calculate tree-related benefits.

[American Forests](#), a nonprofit citizen's conservation organization that focuses on trees and forests, has developed software designed to simplify the process of quantifying certain benefits that tree canopy provides. CITYgreen software is an application that uses embedded formulas and parameters to calculate tree benefits from information that is stored in a GIS. CITYgreen software is technically a third-party GIS extension of ArcView® GIS software available from [ESRI, Inc.](#) Extensions such as CITYgreen can only be used in conjunction with the base GIS program. Extensions consist of databases, scripts, and other objects that expand the capabilities of the base GIS and/or provide shortcuts that simplify various tasks or calculations.

We tested CITYgreen 3.0 software running under ArcView® GIS 3.2 to determine how this product might be used for evaluating progress toward urban forestry goals. CITYgreen and ArcView software was generously contributed by American Forests and ESRI, Inc, respectively, and provided a significant portion of the matching funding required for the NUCFAC cost-share grant that funded this website. At the time of this review (October 2001), later releases of both CITYgreen and ArcView® GIS have become available, but we have not had the opportunity to test them.

CITYgreen 3.0 actually provides two different ArcView extensions: CITYgreen Local Analysis and CITYgreen Regional Analysis. The Local Analysis extension can be used to calculate the economic value of a particular neighborhood greenspace, providing measurements of trees' contributions to stormwater runoff reduction, energy conservation through shading, air pollutant removal (ozone, sulfur dioxide, nitrogen dioxide, particulates 10 microns or less in size [PM10], and carbon monoxide removal), carbon storage and sequestration, and urban wildlife habitat. As the name implies, the Regional Analysis extension is used for regional analyses that cover a wider area. The Regional Analysis extension includes tools for detecting change in vegetation cover using certain types of satellite data and for calculating tree benefits on the scale of a large watershed.

A good working knowledge of how to use ArcView is a prerequisite for successfully using CITYgreen 3.0. The software interfaces for CITYgreen 3.0 and ArcView 3.2 are not completely intuitive, so unless you use these applications frequently, you may need to refer frequently to the manuals for help. In general, the manual provided with CITYgreen 3.0 was fairly helpful and made the extension relatively easy to use. However, in some instances windows shown in the manual did not correspond with onscreen windows. No online support for CITYgreen software was available at the American Forests web site at the time of this review.

# Local Analysis Extension

## Digitizing canopy and other features

To use CITYgreen 3.0 Local Analysis extension functions, the user must prepare a detailed schematic drawing and conduct a detailed tree inventory. Local Analysis calculations require information on the percent of land area covered by vegetation, water, structures, and impervious surfaces. These quantities are determined from GIS layers (or themes in ArcView parlance) that the user digitizes from a base aerial image or plan of a project site. CITYgreen provides special tools which are used to ["heads up" digitize](#) the base map and create a schematic drawing of the project site.

In CITYgreen, tree canopy is digitized by manually superimposing green circles over tree canopies shown in the base aerial photo. One also has the option of digitizing groups of trees as a single polygon, but several of the analyses that CITYgreen provides cannot be run on groups of trees. To test the canopy digitizing function, we digitized the trees in the same aerial photo shown on the page [Comparison of image analysis and dot grids for calculating tree canopy cover](#). We used only the single tree method (superimposed circles) in the example image shown below. This method is fairly fast and directly produces a GIS layer that can be manipulated and analyzed. Each tree is given a unique identifier number by the program.

Although this method was fairly fast and simple, we noted several disadvantages. A certain amount of error is introduced when superimposing circles over the trees, especially because the image of the tree canopy is obscured as the circle is drawn. Canopy circles cannot overlap the edge of the project area or they will not be counted by CITYgreen. This causes problems if sizable numbers of trees are present along the perimeter of the project area. Furthermore, the user cannot modify the sizes of the circles that represent tree canopy through direct data entry. Canopy area and perimeter measurements for each tree in the tree attribute database are calculated from the digitized image when the analysis functions are run.

Canopy cover calculated from the digitized schematic (below right) was 17.38%. Canopy cover on the same image calculated using either [image analysis or dot grid counts](#) was about 21%. Unless tree canopies are very distinct and generally well separated, the CITYgreen method of digitizing canopy is likely to be subject to more error, especially between different evaluators, than these other methods. CITYgreen's alternative method for digitizing tree canopy essentially involves drawing polygons around tree canopy. This method may be more accurate if done carefully, but would be excruciatingly slow on an image such as we used for the example. Furthermore, CITYgreen treats groups of trees digitized as polygons as individual trees, which causes problems in assigning tree attributes.

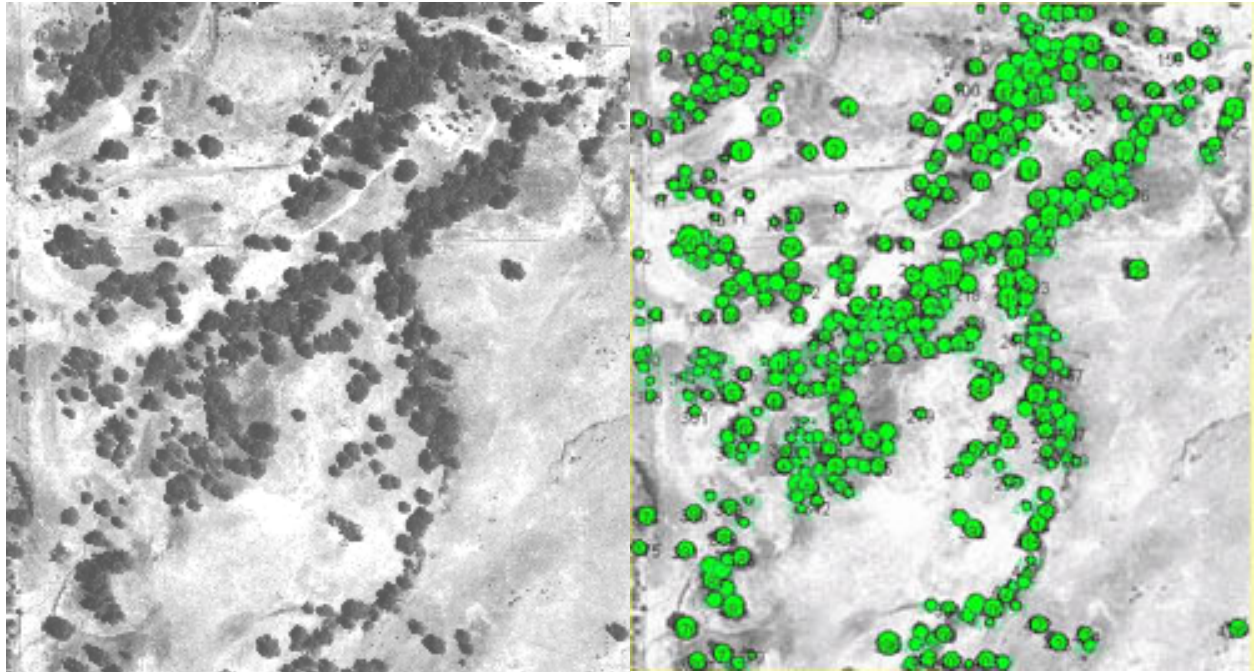

Other elements (i.e., layers or themes) that the user needs to digitize include buildings, impervious surfaces, grasslands, and water bodies. An example of a fully digitized image from a suburban neighborhood, with buildings and impervious surfaces as well as trees, can be found at the [American Forests web site](#). Note that CITYgreen 3.0 does not calculate the area present in each of the land cover classes after digitizing is complete. It requires you to collect and enter field inventory data before it will run these calculations.

## Modeling tree growth

The Local Analysis extension includes a tree growth model that allows a user to estimate the future benefits provided by a population of trees as they increase in size. In the tree growth model, stem diameter (DBH) growth is based on classification of trees as slow (0.1" DBH/year), medium (0.25" DBH/year), or fast growing (0.5" DBH/year). Height growth is modeled in an analogous fashion. CITYgreen models canopy growth by multiplying the the expected growth in DBH by a canopy growth factor specific for each species that was derived from the relationship between DBH and canopy spread measured in the field.

We tested the growth model on the digitized photo shown above right. For purposes of the analysis, we set the species code to "oak" because the western oak species present in the photo (*Q. lobata*, *Q. wislizeni*, and *Q. douglasii*) were not in CITYgreen's master species database. We set the height class to 15-35 ft and health to "good" for all 428 trees in the digitized image. We selected 10 years as the growth increment to model. The figure below shows the original canopy sizes (bright green) superimposed over the projected canopy after 10 years of growth (dark green). Based on our experience, it was clear that the default canopy growth rate for oak in the master database was greater than would actually occur with these species at this site. The user can modify the canopy growth rate in the master database to make it appropriate to local conditions, but local data would be needed to develop realistic numbers.

Trees near the edge of the project pose problems when modeling tree growth. Tree canopy that grows beyond the edge of the project is excluded from any of the environmental calculations that use canopy area. One alternative is to edit the tree theme by moving trees entirely within the site boundaries. This introduces some error into the calculations and alters the actual coordinates of the moved trees, which may be undesirable. Another alternative involves using the "split polygon" tool to manually edit out the portions of the trees that extend outside of the boundary. However, edited trees become irregular polygons and excluded from certain analyses.



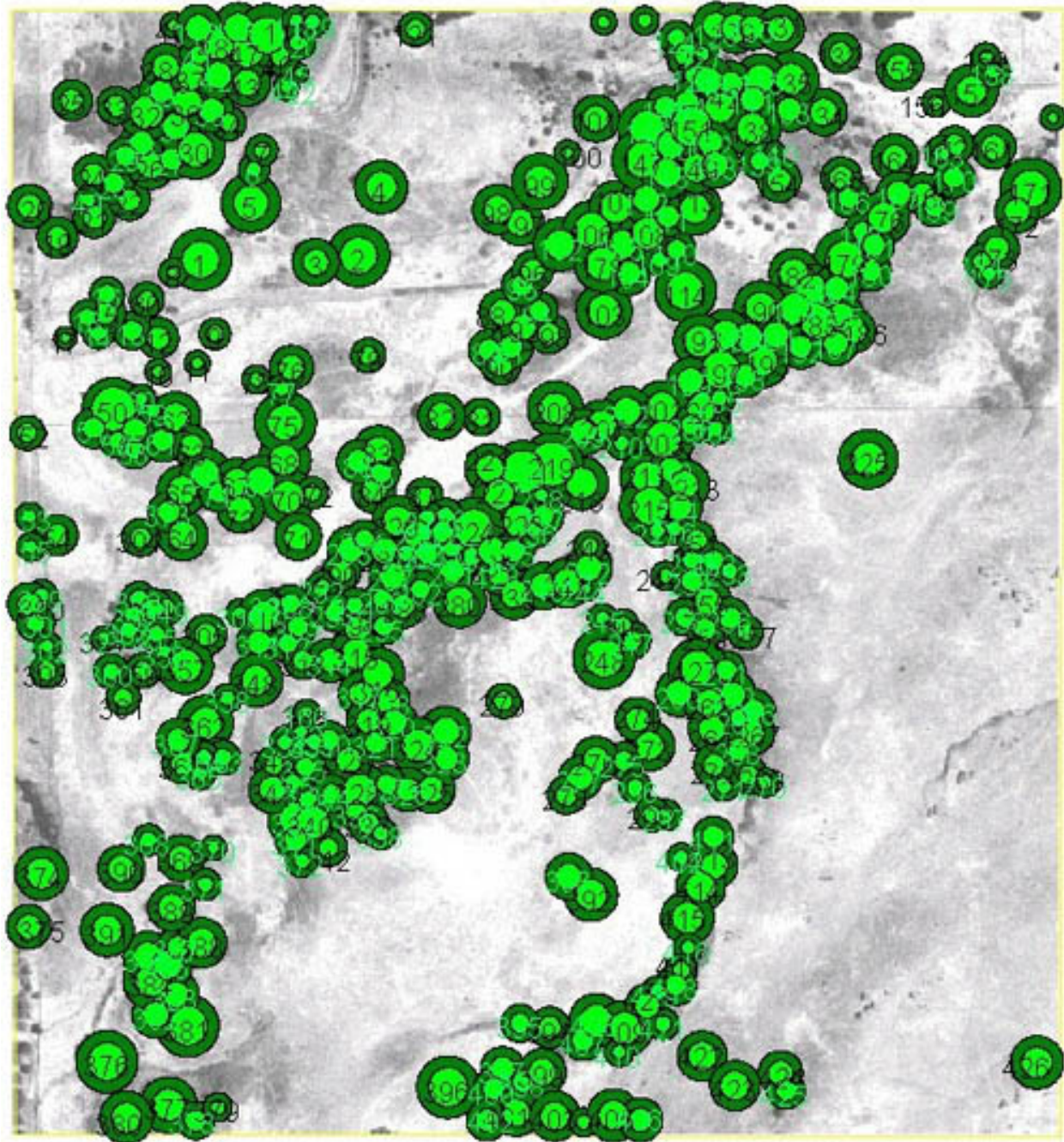

## Calculating benefits provided by trees

Most but not all of CITYgreen's environmental benefits analyses require data in addition to the digitized schematic. The stormwater runoff reduction and air quality analyses only use the canopy size information digitized in the schematic, so these analyses can be run using only the data digitized from an aerial photo or site plan. However, CITYgreen requires that certain tree attribute fields be filled in before any analyses can be run. These include tree species code, trunk diameter, tree height class (< 15 ft, 15-35 ft, > 35 ft) and health class (the program uses a 1 to 5 scale). Hence, to run the stormwater and air quality analyses without these tree data, dummy data must be inserted into these fields in the database. This is most easily accomplished by opening the DBASE-format attribute table using a spreadsheet program and filling in the necessary fields.

The carbon sequestration analysis can also be run without field inventory data if the average diameter class of the tree population is entered for all the trees in the database. The remaining analyses (energy savings, growth models, and wildlife habitat) require information that needs to be collected through [ground survey](#) methods. Once the digitized site schematic is complete, it can be printed out for use in ground truthing and as an aid in collecting detailed field inventory data for the site. Datasheets containing the fields and codes used by CITYgreen are in the appendix of the user manual and are also provided on the CITYgreen CD-ROM. The manual also indicates which fields are required to run the various analyses. The datasheets provide a number of additional fields that might be useful for other purposes, and a user can add additional fields as desired. Hence, the tree database could be used as a tree inventory, although it would not necessarily have many of the specialized functions found in dedicated tree inventory software.

Using dummy data in required fields, we were able to run the analyses for carbon storage and sequestration and air pollution removal. The stormwater runoff analysis failed to run as described in the manual, which did not match exactly with the program. Nonetheless, we were able to model stormwater runoff with our data using the Off-site menu. The Off-site menu allows the user to model stormwater runoff by entering the required information directly in an input window that does not require linkage to a digitized schematic. The off-site menu for stormwater runoff modeling is especially useful for comparing the impacts of different scenarios involving, for instance, varying levels of canopy cover.

## Regional Analysis extension

The Regional Analysis extension of CITYgreen includes a satellite data classification program and a watershed analysis program based on the 1992 National Resources Inventory (NRI) developed by the US Department of Agriculture. These two programs are independent and do not interact with each other in any way.

### Satellite data classification program

We did not test the satellite data classification functions of CITYgreen. According to the user manual, the program uses a Normalized Difference Vegetation Index (NDVI) to classify pixels in a satellite image as either vegetation or nonvegetation, using information from the red and near infrared spectral bands. This means that tree canopy cannot be distinguished from other vegetation, such as grass. A statistical program automatically analyzes the satellite data and reports the vegetative cover in percent cover categories (0%, 1-5%, 6-20%, 21-40%, 41-60%, and > 60%). A new image is created which displays the vegetation cover classes. Printing functions allow the image to be printed along with legends and a frequency distribution of vegetation cover classes. If satellite photos of the same region are available for different years, a change detection analysis can be run which will produce a new image showing vegetation cover change in the region.

Satellite data files must be in a band interleaved by pixel (.bip) format to function properly. An ArcView world transformation file must be associated with the .bip file prior to processing. The satellite data must be projected in UTM with map units in meters. Landsat MSS, TM, SPOT, and EOSAT data can be stored or converted to this format.

### Watershed analysis program

The regional watershed analysis program in the Regional Analysis extension uses the 1992 NRI data to calculate the environmental benefits that vegetation provides in terms of carbon storage and sequestration, air pollution mitigation, soil erosion reduction, and stormwater runoff reduction for an entire watershed. We tested the program for our local watershed, the Lower Sacramento (CA), and found that the program functioned as described in the manual. The results of running the analysis functions are shown in the presentation below, which was prepared using an ArcView template preprogrammed by CITYgreen. Other layouts could be create using ArcView tools. Labels in the figure are county names, some of which did not print. The Lower Sacramento watershed is highlighted in yellow.



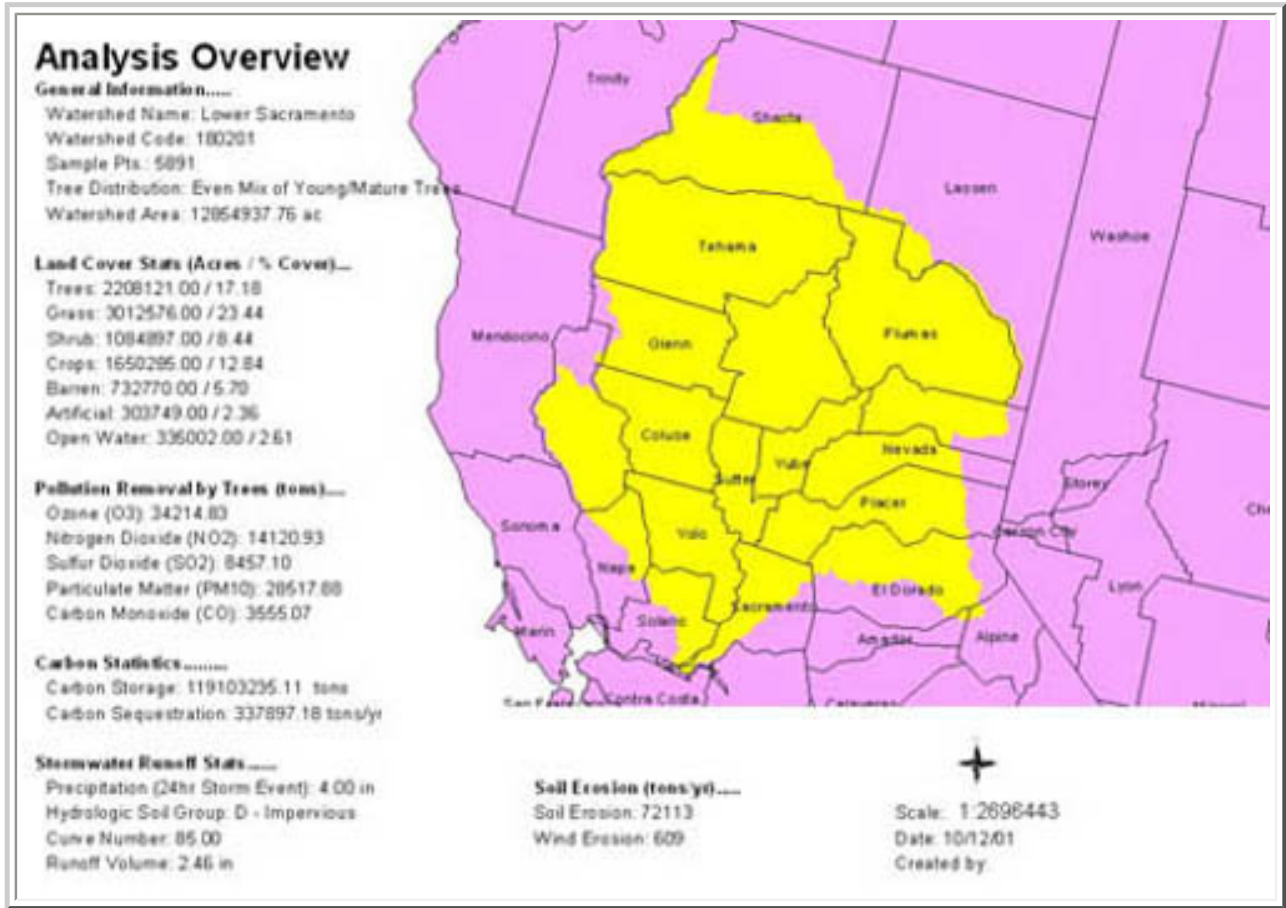

The program allows the user to model how changes in land cover statistics will affect air pollution removal by trees, carbon statistics, and stormwater runoff statistics. CITYgreen includes a template for printing results of the model scenario in an attractive format. Effects of changing land cover statistics on soil erosion cannot be modeled.

## Final considerations

Modeling environmental benefits provided by trees and other vegetation is an ongoing topic of research. CITYgreen provides such modeling capabilities to non-experts, which is both its strength and weakness. By allowing routine calculations of tree-related environmental benefits, CITYgreen provides a way to take these benefits into account in community forest planning on both a local and regional scale. Nonetheless, the cookbook approach used by CITYgreen has the potential to result in flawed or unrealistic analyses in the hands of users that do not appreciate the intricacies and uncertainties involved in these analyses.

For instance, USDA Forest Service research indicates that for urban trees, the amount of carbon expended in maintenance activities over the life of a tree may exceed that stored by the tree. Energy conservation may be the main way in which trees reduce atmospheric carbon, but avoided carbon emissions associated with reduced energy use is not modeled in CITYgreen. There is also considerable uncertainty about the amount of carbon stored by forests. See for example: [http://www.royalsoc.ac.uk/policy/carbonsinks\\_sum.pdf](http://www.royalsoc.ac.uk/policy/carbonsinks_sum.pdf) (the full report is at <http://www.royalsoc.ac.uk/files/statfiles/document-150.pdf>). Hence, the carbon storage and sequestration numbers generated by CITYgreen should be interpreted with caution. As a second example, CITYgreen's air pollution removal analysis is based on research conducted by Dr. David Nowak, of the USDA Forest Service, and is based on data from eight large US cities (Atlanta, Austin, Baltimore, Boston, Milwaukee, New York, Philadelphia, and Seattle). Pollutant levels in these cities may not be representative of levels present at a given project site or watershed, leading to erroneous (generally excessive) estimates of air pollution removal benefits.

The CITYgreen manual provides technical details on the analysis programs used to calculate environmental benefits and provides a list of references used to develop the analyses. In some cases, other programs exist that can be used to directly calculate some of the quantities calculated in CITYgreen. For example, the stormwater runoff analysis is based on the Urban Hydrology for Small Watersheds model (also called Technical Release 55 or TR-55) developed by the US Natural Resources Conservation Service (NRCS). A Windows-based version of the current TR-55 model is available for free download from NRCS at <http://www.wcc.nrcs.usda.gov/water/quality/common/tr55/tr55-beta.html>.



## Public polling

---

### Uses:

Evaluating public attitudes and knowledge about trees and urban forest management.

### Materials needed:

Varies with the type of survey being conducted. See discussion below.

### Notes:

The use of polling or surveying to assess public opinions, attitudes, beliefs, and knowledge is well known to most people. On almost any day, the news media report on the results of a poll or survey on some pressing topic. Polling can be useful in assessing the knowledge and attitudes of the community with respect to urban forestry issues. Properly designed polls can also be used to evaluate whether an ordinance, educational program, or other management activity has brought about changes in knowledge, attitudes, and practices in the community. Information is normally gathered from the public either through [interviews](#) or [self-completed questionnaires](#).

## Interviews

Compared with questionnaires, interviews generally have greater flexibility, tend to elicit a higher response rate, and allow for more precise selection of respondents. However, persons conducting interviews need to be carefully trained to avoid introducing bias into the data.

Interviews may be conducted either in person or by telephone. Telephone interviews are less expensive to conduct, allow for better sampling designs, and can be used in conjunction with computers. Computer-assisted telephone interviewing (CATI) systems are available and can increase the efficiency of telephone interviews. A CATI system can be used to help the interviewer adjust their questions based on information obtained during the interview, and allows for the direct entry of data as the interview proceeds.

## Self-completed questionnaires

Self-completed questionnaires have the advantage of being easier to administer than interviews.

Questionnaires are most commonly sent and returned by mail. Respondents have more opportunity to think about questions or look up information for a self-completed questionnaire than in an interview. While it is now possible to set up questionnaires that would be accessed via the Internet, the sample responding to an Internet survey may not be especially representative of the population as a whole or even of the portion of the population that uses the Internet.

Typically, prior to the main survey mailing, the questionnaire is pretested on a small sample. Any problems that are identified in the construction of the questionnaire can then be corrected.

Several techniques are commonly employed to boost the return rate for mail surveys. These include the use of advance notification, attractive first-class stamps rather than bulk postage, hand addressing, postage-paid return envelopes, carefully-timed reminder postcards, and repeat mailings of the questionnaire to nonrespondents. Token incentives included with the survey are sometimes used to increase the return rate, but these will also increase survey costs. Incentives may also introduce bias into the returns if they tend to motivate some groups more than others.

## Survey design considerations

Much of the difference in cost between the various methods is related to the logistics of data collection, since design and analysis costs will be similar. In-person interviews are generally the most costly and complex surveys to conduct, due to the logistics of traveling door-to-door. The cost of telephone surveys will vary with the length and complexity of the survey and the sample size. Costs of the mail survey vary with the size of the mailing and the number of follow-up mailings used.

Good survey design and sampling technique are critical to the success of sample surveys conducted by any method. Care must also be taken in the data collection and entry process, to avoid introducing errors. Finally, even a well-conducted survey will not yield meaningful results if data analysis and interpretation are flawed. Thus, while the concepts behind public polling are reasonably straightforward, there is a fair amount of art and science involved in conducting a useful study. Gross design and execution errors can lead to meaningless or misleading results. More subtle errors may not completely invalidate survey results, but can decrease the reliability of the study.

If you are interested in conducting a public survey but lack the necessary technical background or resources, there are various sources of assistance available. Survey research units are associated with a number of state college and university campuses. Some of these units can contract with cities or counties to design or conduct surveys. Others may provide information or assist in studies on a cooperative basis. In addition, a number of private firms specialize in conducting public surveys primarily for market research. The scope of services provided and quality of work performed by these or other consulting firms can vary widely, so careful shopping is advised.

## Sampling considerations for public polling

For all but the very smallest municipalities, assessments of citizen attitudes and knowledge will be based on polling a representative sample of the total population. While most of the points noted under [Sampling from Populations](#) apply, demographic factors also need to be considered to avoid bias in the study design. For instance, [Sommer et al](#) (1990) found that compared to younger citizens, older citizens were more likely to have negative opinions about street trees in front of their homes. It may be desirable to account for differences due to age, sex, sociological, or other demographic factors in the survey. Such information may help local

governments decide whether education or other programs need to be targeted toward certain segments of the population.

### **Evaluation example: *Homeowner attitudes toward trees***

[Sommer \(1989\)](#) gives the following example of how information from a mail survey can be used in urban forestry management. European elms are a common street tree in the downtown area of Sacramento, California. These large trees are attacked by elm leaf beetle each summer, and the mess associated with these infestations had drawn numerous complaints. In response, the city had initiated an elm replacement program. This program provoked a public outcry, although not necessarily from neighborhoods directly affected by elm replacement. The city conducted a mail survey of householders in the downtown area and found that the majority of the property owners liked their elm trees, and wanted them retained. This data was then used to revise city policies regarding elms.



## Defining special trees: heritage, historic, and landmark trees

---

As noted in our discussion of provision 31, individual trees may be considered important community resources because of unique or noteworthy characteristics or values. Such trees have been described in ordinances as heritage, historic, landmark, legacy, special interest, significant, or specimen trees or various permutations of these terms (e.g., heritage oak, exceptional specimen tree). In some ordinances, trees are simply labeled protected trees (i.e., trees afforded protection by the ordinance). Regardless of the term used, the concept is the same: trees with certain characteristics are singled out for special consideration in the ordinance. Most commonly, one or more of the following criteria are used to define a special status tree:

**Size** - Some component of tree size, most frequently trunk diameter, may be used to define a special status tree. Most commonly, a given diameter at 4.5 ft above grade (i.e., diameter at breast height or DBH) is used as the size standard. Additional rules are typically needed to handle trees that are multi-trunked or branch below 4.5 ft. Because the relationships between DBH and canopy spread or DBH and tree age vary by species, different tree diameter standards may be applied to different species.

Although a tree diameter standard is fairly objective, the threshold diameter is often set more or less arbitrarily. As such, management decisions based solely on a threshold diameter may not be particularly logical. For example, if the threshold diameter for protecting a tree is 24 inches DBH, a tree with a diameter of 23.9 inches would be ignored, even though it might have a greater canopy spread than a tree with a larger DBH. Furthermore, the measurement of DBH with standard equipment such as diameter tapes or calipers is subject to errors related to trunk or bark irregularities and minor shifts in the location of the measuring device. A tree with a DBH measured as 24.2 inches by one observer could be measured at 23.5 inches by another observer. These problems are minimized when small threshold diameters (e.g., 3 inches) are used.

Other components of tree size, such as maximum canopy spread or height, may also be considered independently or in conjunction with tree diameter. The National Register of Big Trees, maintained by American Forests, uses a point system to rate tree size. Points for each tree are calculated by summing trunk circumference (at 4.5 ft) in inches, tree height in feet, and one-quarter of the average crown spread in feet. This system is used to determine "champion" trees for each species. Some ordinances expressly confer special tree status on state or national champion trees. More local "champion" trees could be defined using the same methods.

**Species** - Special status may be conferred only to certain species of trees. Special status trees are often, but not always, important locally native species or trees that are associated with the character of a community. Certain species that are relatively rare in an area, whether native or not, may also be granted special status. In some cases, species is used to specifically exempt certain trees from special status regardless of size. For instance, weedy trees such as tree-of-heaven (*Ailanthus altissima*) or trees used for commercial purposes (e.g., fruit trees, plantation lumber or pulp trees) may be excluded from consideration as special status trees. Unless

interspecific hybrids are present in an area or the taxonomy of a species changes, species is probably the most objective criterion used in defining special status trees.

**Age** - Especially old trees are a link to the past, so many definitions of special status trees include age as a criterion. In practice, tree age is fairly difficult to determine in standing trees unless documentation of tree age exists from historical accounts, photographs, or associations with historical structures. Tree age is sometimes inferred from tree size, especially DBH. However, the relationship between age and DBH varies with species, site quality, management history, and other factors, so DBH is usually only a crude estimator of tree age. Determining age by increment boring is theoretically possible, but is potentially damaging to the tree and is fraught with difficulties if trees are large, have very hard wood, or are decayed in the center.

**Historic significance** - A tree may be associated with a notable local or regional historical event, person, structure, or landscape. Almost every tree that has been around for a while has some historical significance, whether it is recognized or not. Determining whether the historical significance of a given tree is sufficiently notable is therefore a subjective matter. Historic tree status is typically granted by a governing (e.g., city council) or advisory body (e.g., tree commission). Some ordinances automatically confer historic status on trees designated as historical landmarks by certain other organizations (e.g., historical societies). In addition, ordinances may assign special status to trees dedicated or planted as public memorials.

**Ecological value** - All trees serve a variety of ecological functions. Certain trees or groups of trees may have especially high ecological value because of their location, size, species, and/or condition. For example, a given tree may be an important roost, nesting site, or food source for certain wildlife species; it may be situated in a site where it plays a critical role in stabilizing soil or providing shade needed by other plant or animal species; it may be an important genetic resource for a local tree population or the species as a whole. Input from trained biologists and ecologists may be necessary to document particular ecological values that may not be obvious to the general public.

**Aesthetics** - Since beauty is in the eye of the beholder, assigning special status on the basis of aesthetics is always highly subjective. A tree may have special aesthetic value due to its form, whether it is especially perfect and symmetrical or notably craggy and idiosyncratic. Also, the function that a tree serves in a landscape may be sufficient to justify special status; for example, a landmark pair of trees that frame an entrance. In the absence of other noteworthy characteristics, it may be contentious to base special status upon aesthetics alone.

**Location** - Trees in particular locations may be accorded special status in recognition of the important aesthetic or ecological functions that they serve. Proximity to a thoroughfare can be used to classify a tree as a street tree, which may be accorded special status whether or not it is in the public right-of-way or is under public or private care. Trees located along or within a set distance from watercourses may also be given special status due to their importance in stabilizing streambanks or providing shaded riverine habitat. In some cases, the location of a tree is considered in conjunction with size or species parameters.

**Required plantings and retained trees** - If trees have been preserved or planted as a requirement of development, the community has a vested interest to ensure that the trees are protected. The purpose of planting and tree retention is to develop mature tree canopy, and this cannot occur if the subject trees are eliminated, ruined by topping or other poor maintenance practices, or replaced frequently with young trees. By explicitly providing special status to such trees in the ordinance, a jurisdiction may be able to provide a higher level of regulatory protection to such trees and increase the penalties associated with unauthorized damage to or removal of the tree.

**Other unique characteristics** - This grab-bag term may be added to the list of criteria used to designate special

status trees because it is difficult to anticipate all possible situations of significance. For example, a given tree may become a local or regional cultural icon due to an event or apparition that is associated with it. This criterion will again be subjective and typically may be invoked through the approval of a governing body.

Because each criterion above has clear limitations and difficulties, most definitions include a combination of criteria. The following definition include examples of many of the criteria discussed above.

*Protected tree includes all of the following:*

*(1) Private protected tree means any tree with a DBH of six inches or more located on any lot within twenty feet of a street right-of-way (including an approved private street or other access easement) or a tree with a DBH of eight inches or more located within ten feet of any other property line, or a tree with a DBH of twelve inches or more located elsewhere on the lot.*

*(2) Public protected tree means any tree located on lands owned by the city, or other governmental agencies or authorities, or any land upon which easements are imposed for the benefit of the city, or other governmental agencies or authorities, or upon which other ownership control may be exerted by the city, or other governmental agencies or authorities, including rights-of-way, parks, public areas and easements for drainage, sewer, water and other public utilities, with:*

- (i) A DBH of six inches or more located within a city or other governmental right-of-way, or*
- (ii) A DBH of six inches or more and located on any lot within twenty feet of a street right-of-way, or*
- (iii) A DBH of eight inches or more located on any lot within ten feet of any other property line, or*
- (iv) A DBH of twelve inches or more located elsewhere on the lot.*

*(3) Exceptional specimen tree means any tree which is determined by the City Council to be of unique and intrinsic value to the general public because of its size, age, historic association or ecological value or any tree designated a Florida State Champion, United States Champion or World Champion by the American Forestry Association. The Chief shall keep a record of all specimen trees so designated and their location.*

[Jacksonville, FL: Ordinance code Title XVII, Section 656.1203bb]

As noted in provision 31, special tree status is best targeted at individual trees, typically in areas that do not have natural stands of trees. When stands of trees or patches of forest or woodland are the topic of concern, the approach described in [provision 32](#) (forest and woodland conservation) may be more appropriate.





## Definitions: Tree banks and tree banking

---

The terms "tree banking" and "tree bank" are sometimes used in tree ordinances. The terms have an appealing ring to people who are interested in conserving tree resources because of the mental images they conjure up. However, these terms do not have a single, widely-accepted definition either as used in ordinances or as used in the wider world of forestry.

In tree ordinances, the term "tree bank" almost always refers to what is more generically termed [off-site mitigation](#). Many city and county tree ordinances require tree planting, most commonly to replace trees that have been removed or damaged during site development and/or construction. In some cases, tree planting may be required to meet overall tree canopy cover or density standards in areas that have little or no natural tree cover. If it is not possible to plant all of the required trees on the parcel that triggers the planting requirement some type of off-site mitigation (i.e., "tree banking") may be required.

"Tree banking", as the term is most commonly used in tree ordinances, generally comes down to one of the following off-site mitigation tactics:

**1. Planting trees in off-site mitigation banks**, i.e., areas set aside as a permanent receiver sites for tree plantings. The mitigation bank is typically public land, although this would not need to be the case, and may or may not have existing tree resources. Planting may be carried out directly by the developer/ landowner, or the developer/landowner may pay into a dedicated municipal tree planting fund (or sometimes a more general fund which supports tree planting) in lieu of planting required trees. The term "tree bank" may be used to describe the actual planting site, as in the following example:

*Tree Bank: A site such as a school or public park, where the owner/developer shall donate and plant the required trees when it is not feasible to plant the required trees within their site's project area.*

[Fulton Co., GA: Tree Preservation Ordinance Sec. I.III.33]

Alternatively, in some communities, the fund used for in-lieu fees is referred to as the "tree bank".

**2. Establishing tree/forest preserves** on public or private land through transfer of title to a public agency, the use of conservation easements or deed restrictions, or other methods. In contrast to the first tactic, trees or forested areas to be "banked" or preserved are already in place. As above, establishment of the preserve may occur directly (for example, through the dedication of a portion of a parcel to be developed as public parkland or open space) or through the use of in-lieu fees. The above tactics are not mutually exclusive and a tree ordinance may allow for planting, protection, direct mitigation, and in-lieu fees.

The term "tree bank" has also been used to describe other horticulture- or forestry-related concepts or programs. These include:

- **Temporary storage of trees removed from a site being developed.** Trees (typically small diameter) are removed with a tree spade or in some other fashion, stored (i.e., "banked") temporarily, and subsequently replanted either at the same site or elsewhere. This technique could be used to help conserve locally-adapted native trees or locally rare trees, but may not be particularly cost effective for many situations.
- **In-ground tree nursery used as a source of larger planting stock.** Trees seeds, seedlings, or small saplings are planted in either temporary (e.g. vacant lots) or permanent nursery areas for later transplantation. Such nurseries may be used as a source of low-cost planting materials for community groups or residents. This approach could also be used provide a source of locally native trees that would not otherwise be available from commercial sources.
- **Plantings of trees in protected areas for the purpose of maintaining genetic reserves.** An organization known as the Forest Ecosystem Rescue Network has used the Tree Bank term to describe a program intended to create genetic reserves of tree species in locations outside their natural ranges.
- **Database of sources of free trees available to conservation groups.** A program known as the Tree Bank Register (Great Britain) maintains a database of sources of tree planting stock that are available for free distribution to private citizen groups such as conservation organizations.

Although "tree bank" has a nice ring to it, it has been applied to a wide variety of programs (and in some cases to organizations). It is certainly legitimate to define the term in a tree ordinance and use it locally in that sense. However, the fact that different jurisdictions use the term in different ways may lead to confusion. In general, we recommend the use of more descriptive (albeit more prosaic) terms such as "tree planting fund" or "off-site mitigation planting" to describe the off-site mitigation tactics that are specified in the ordinance.

Return to provision: [31](#), [32](#)

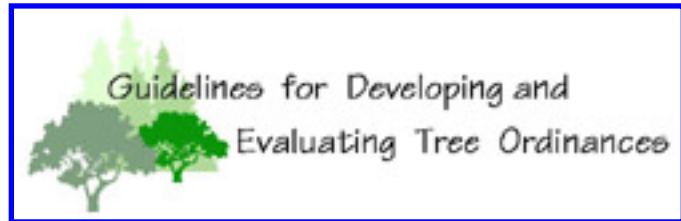

## Concepts: Mitigating for tree loss

---

[Overview of mitigation tactics](#)

[Mitigation measures](#)

[Mitigation location](#)

[Use of in-lieu fees](#)

[Recommendations](#)

## Overview of mitigation tactics

Provisions that seek to protect either individual trees (provisions 30, 31) or stands of trees (provision 32) normally require mitigation as a condition for approving destruction of, or damage to, tree or woodland/forest resources.

Essentially all mitigation is based on the following two measures:

**1. Protect existing trees or woodland/forest resources**

**2. Plant new trees** (this may include more general restoration of woodland/forest ecosystems)

Relative to the parcel or project area where tree removal occurs, mitigation measures can be implemented at one or both of the following locations:

**A. On site**

**B. Off site**

The basic mitigation measures and locations give rise to the four combinations shown in the following table. Almost all mitigation tactics can be grouped into one of these four categories. Although simple in concept, these four basic mitigation tactics can be implemented in a wide variety of ways, each of which have different consequences for the community forest. Some of the most common examples of each mitigation tactic are listed in the table below.

<b>Mitigation measures and locations</b>	<b>1. Protect existing trees or stands</b>	<b>2. Plant new trees and/or woodland/forest restoration</b>
<b>A. On site</b>	<ul style="list-style-type: none"> <li>• Protect existing individual trees and/or stands through project design: <ul style="list-style-type: none"> <li>- relocate structures or infrastructure</li> <li>- utilize specialized construction methods to minimize damage to tree roots</li> <li>- set aside portions of project area as woodland/forest preserves</li> </ul> </li> </ul>	<ul style="list-style-type: none"> <li>• Plant new trees in landscaped portions of parcel to replace those removed</li> <li>• Plant new trees on portions of the project area set aside as woodland/forest preserves</li> </ul>
<b>B. Off site</b>	<ul style="list-style-type: none"> <li>• Purchase land with existing trees or stands by public agency or land trust and set aside as permanent woodland/forest preserves</li> <li>• Establish permanent conservation easements on individual trees or stands on private lands to protect those tree resources from removal.</li> </ul>	<ul style="list-style-type: none"> <li>• Plant new trees on approved public lands <ul style="list-style-type: none"> <li>- landscaped areas</li> <li>- rehabilitation and reforestation of degraded natural woodlands / forests</li> <li>- afforestation of lands that currently lack trees (usually former woodlands/forests)</li> </ul> </li> <li>• Plant new trees on approved private lands <ul style="list-style-type: none"> <li>- land trust holdings</li> <li>- privately-owned woodland/forest preserves protected with conservation easements</li> </ul> </li> </ul>

Many ordinances allow for more than one form of mitigation. The permitting authority selects and approves the specific option or combination of options that mitigate appropriately for the impacts of a given project. In some cases, a community can establish a general prioritization of possible mitigation tactics (e.g., protection preferred over planting, on site preferred over off site). However, because the constraints and opportunities provided by each situation can differ, the permitting authority should have some flexibility in prioritizing mitigation tactics.

## Mitigation measures

Each mitigation measure (protection or planting) has advantages and disadvantages with respect to various management objectives, as shown in the following table.

	<b>Mitigation measures</b>	
<b>Management objective</b>	<b>1. Protect existing trees or stands</b>	<b>2. Plant new trees or woodland/forest restoration</b>

<p><b>1. Prevent net loss of tree canopy or forest type</b></p>	<p>If some trees are protected as a condition for removing other trees, net loss of canopy or forest type always occurs over the short term. If mitigation trees are mature, additional long term canopy loss is possible when the mitigation trees die. The degree of loss is a function of the mitigation ratio (e.g., 1 for 1 mitigation could lead to 50% loss).</p>	<p>Over the short term, canopy is normally reduced. Planting or afforestation has the potential to prevent long-term net loss if:  <b>(a)</b> mitigation ratio is at least 1 <u>successful</u> new tree for each tree removed;  <b>(b)</b> replacement species have similar mature canopy spread;  <b>(c)</b> replanting or natural regeneration maintains the mitigation planting in perpetuity</p>
<p><b>2. Maintain mature tree canopy</b></p>	<p>Some mature canopy can be maintained over the short term. Long term maintenance depends on whether provisions have been made for natural regeneration and/or eventual replanting.</p>	<p>Loss of mature canopy is not mitigated over the short term (i.e., not until new plantings mature).</p>
<p><b>3. Maintain aesthetics associated with existing trees</b></p>	<p>Aesthetic impacts associated with loss of mature trees can be partially mitigated, depending on location of mitigation trees.</p>	<p>Aesthetic impacts associated with loss of mature trees are not mitigated over the short term.</p>
<p><b>4. Maintain habitat values</b></p>	<p>Habitat values associated with mature trees and existing woodlands/forests may be partially mitigated over the short term, depending on:  <b>(a)</b> habitat elements provided by mitigation trees;  <b>(b)</b> the location of the mitigation trees with respect to other trees or habitat elements;  <b>(c)</b> level of disturbance (both initial and ongoing) in the mitigation area</p>	<p>Loss of habitat values associated with mature trees and existing woodlands/forests are not mitigated over the short term. New plantings do have habitat values, but these typically differ from those associated with mature trees and stands.</p>
<p><b>5. Maintain species diversity</b></p>	<p>The degree of mitigation provided depends on the species composition of protected areas. Locally uncommon or rare tree species can be conserved at least over the short term. Diversity of species other than trees (e.g., understory plants, animals) may also be conserved.</p>	<p>Depending on species used in planting, tree species diversity can be increased or decreased relative to preexisting tree or woodland/forest resources. The level of diversity among non-tree species depends strongly on the plant community and restoration / management practices used. Undesirable nonnative "weedy" species may be more prevalent in new plantings compared to existing woodlands/forests..</p>

<b>6. Maintain age diversity</b>	Age diversity can be maintained if a variety of age classes are represented in the protected trees and stands.	Age diversity of forest or stand is usually reduced. Plantings typically give rise to even-aged stands.
<b>7. Conserve local tree genetic resources</b>	Conservation of germplasm from local tree populations and populations of other woodland/forest organisms is possible if a sufficient number of individuals are protected. However, maintaining a few widely scattered individuals of outcrossing wind-pollinated species (e.g., many oaks) might not permit seed set and would effectively eliminate regeneration.	Local genetic resources may be conserved if seed or other propagules from local populations are used. Use of non-local planting stock in woodland/forest plantings may be a source of "genetic pollution" and may accelerate the loss of genetic traits associated with local adaptation.

For plantings, several additional factors must be considered, as summarized below.

<b>Factor</b>	<b>Options</b>	<b>Comments</b>
<b>Planting date</b>	During or after construction of applicant's project	Delaying the planting relative to the applicant's project activities may allow for better seasonal timing of the planting. However, it may be useful to set a time limit (e.g., within 1 year after applicant's project is completed) to avoid developing a backlog of unplanted trees.
<b>Selection / purchase of planting stock</b>	City / county, contractor, or applicant	Applicant fees may be collected by the city/county to purchase planting stock, or applicant may buy stock directly. The city/county should set and enforce strict standards for planting stock quality.
<b>Installation</b>	City / county, contractor, or applicant	Installation by the city/county or its contractors is funded from applicant fees. Plantings by the applicant or contractors should be subject to strict standards, monitored, and bonded for performance to ensure quality.

## Mitigation location

Many management objectives can be met equally well with on-site and off-site mitigation. However, the location of the mitigation has an impact on several management objectives as noted below.

	<b>Mitigation location</b>	
<b>Management objective</b>	<b>A. On site</b>	<b>B. Off site</b>
<b>1. Mitigate for local effects of tree removal</b>	Local effects of tree loss can be at least partially mitigated.	Local effects of tree loss may not be mitigated if receiver site is distant from the site of tree removal.
<b>2. Maintain habitat value</b>	Ability to maintain contiguous stands that conserve habitat value may be severely limited, especially on small parcels. Level of disturbance may also degrade habitat value.	More opportunities may exist to maintain stands that are large, contiguous with other stands, and relatively undisturbed, thereby maximizing habitat value.
<b>3. Conserve local tree genetic resources</b>	Conservation of germplasm from local tree populations and populations of other woodland/forest organisms is possible.	Local genetic resources may not be conserved if the receiver site is distant from the site of tree removal.

Several other issues that should be considered when choosing between on-site and off-site mitigation are summarized below.

	<b>Mitigation location</b>	
<b>Issue</b>	<b>A. On site</b>	<b>B. Off site</b>
<b>Area and/or tree resources available for mitigation</b>	May be limited, especially in small parcels or for projects that occupy a large proportion of the parcel.	Generally not limiting, but availability of potential mitigation sites close to the project site may be limited.
<b>Location of mitigation area</b>	Relatively few options for location, especially on small project sites.	Potentially more flexibility on location of mitigation area, but depends on the availability of suitable public or private receiver sites.
<b>Ownership of mitigation area</b>	Normally owned by applicant. Applicant may be required to dedicate the mitigation area or a conservation easement on the area to the city / county, other public agency, or a land trust.	Normally not owned by the applicant. Mitigation area is usually owned by a the city / county, a government agency (e.g., state parks), or a land trust. Privately-owned mitigation areas are possible if the receiver sites are protected with permanent conservation easements.

<b>Maintenance responsibilities</b>	Applicant typically maintains trees if they retain ownership of mitigation area. City / county has monitoring and enforcement responsibilities to ensure that tree resources are maintained. If dedication of mitigation areas is required, local government or land trust maintains trees.	Mitigation site landowner, who is generally not the applicant, maintains trees. City / county has monitoring and enforcement responsibilities to ensure that tree resources are maintained.
<b>In-lieu fees</b>	Generally not necessary.	Commonly used.

## Use of in-lieu fees

When off-site mitigation is required, many jurisdictions allow the applicant to pay fees to the local government in lieu of completing the actual off-site mitigation. In many jurisdictions, in-lieu fees are the only option provided for off-site mitigation. In most cities and counties in-lieu fees are deposited into a dedicated account which is used for tree planting and maintenance and/or the acquisition of woodlands/forests through direct purchase or the purchase of conservation easements. Such accounts are sometimes referred to as "[tree banks](#)".

The main advantage of using in-lieu fees is the relative simplicity of this approach. Rather than requiring each applicant to negotiate for off-site land purchases or conservation easements, the local government handles all of the off-site mitigation arrangements. Consequently, the local government must have the organizational structure necessary to ensure that mitigation trees are planted and will survive over the long term, and/or that reserves on public or private lands are managed to perpetually sustain forest resources. Fees that are collected must be sufficient to pay for the direct and indirect costs associated with the mitigation tree planting, maintenance, and monitoring programs.

Furthermore, if trees planted or preserved as mitigation are to be maintained in perpetuity to offset tree loss, sufficient reserves must be available to establish an endowment to pay for eventual replanting. If in-lieu fees only support a single generation of trees and natural regeneration is not a possibility on the receiver site, net canopy loss will occur over the long term. This is especially the case for trees planted in horticultural situations (e.g., roadsides or parks), which typically have a relatively short life span.

A related problem is that in-lieu fees should be specifically restricted to additional mitigation plantings that are above and beyond the community's regular planting programs. If in-lieu fees are used only as a replacement for tree planting previously supported by the local government's general fund, the total amount of funds available for tree planting might actually be reduced, and public tree planting would be insufficient to mitigate for tree loss in both public and private lands.

## Recommendations

1. Allow for the full range of mitigation options (on and off site, protection and planting, in-lieu fees) to provide flexibility to deal with a range of different permit situations.
2. Permitting authority should have the option to select and/or approve appropriate



mitigation options (including a combination of tactics) based on the local government's management goals and priorities, and the particular circumstances of each project.

3. Trees or woodland/forest resources maintained by the applicant will need to be monitored by the local government to ensure and enforce compliance. The ordinance should expressly provide this authority.

4. Fees charged should be sufficient to provide for ongoing monitoring and maintenance, including eventual replanting. If direct mitigation by applicant is allowed, additional fees may be necessary to provide for monitoring, maintenance, and enforcement.

[< Previous](#)

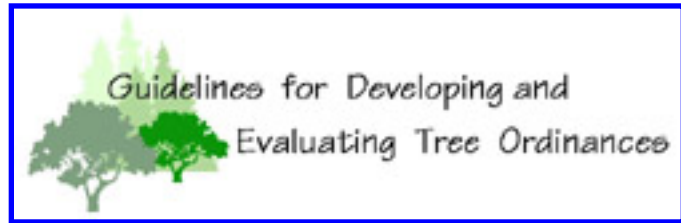

## Literature Cited

---

Bernhardt, E.; Swiecki, T. J. 1991. Guidelines for developing and evaluating tree ordinances. Prepared for: Urban Forestry Program, California Department of Forestry and Fire Protection, Sacramento, CA. 76 p. ([Download from UFEI site](#))

Bernhardt, E.; Swiecki, T. J. 1993. The state of urban forestry in California - 1992. Prepared for: Urban Forestry Program, California Department of Forestry and Fire Protection, Sacramento, CA. 91 p.

Center for Urban Forest Research 2001a. Air Quality and Parking Lot Shade. Web page. USDA Forest Service, Pacific Southwest Research Station, Davis, CA. Available online at <http://wcufre.ucdavis.edu/air.htm#Parking>

Center for Urban Forest Research 2001b. City of Davis Parking Lot Tree Shade Ordinance Amendments. Web page. USDA Forest Service, Pacific Southwest Research Station, Davis, CA. Available online at <http://wcufre.ucdavis.edu/parkordinances.htm>

Coder, K. 1996a. Assessing Construction Damage: Tree Damage Exposure Values and Recovery Times. The University of Georgia, Cooperative Extension Service, Forest Resources Unit Publication FOR 96-036. Available online at <http://www.forestry.uga.edu/warnell/html/service/library/for96%2D036.html>

Coder, K. 1996b. Construction Damage Assessments: Trees and Sites. The University of Georgia, Cooperative Extension Service, Forest Resources Unit Publication FOR 96-039A. Available online at <http://www.forestry.uga.edu/warnell/html/service/library/for96%2D039a.html>

Council of Tree & Landscape Appraisers. 2000. Guide for plant appraisal. 9th edition. Champaign, IL: International Society of Arboriculture.

Daubenmire, R. 1959. A canopy-coverage method of vegetation analysis. Northwest Science 33:43-64.

Galvin, M.F.; Wilson, B.; and Honeczy, M..1999. Maryland's Forest Conservation Act: A Process for Urban Greenspace Protection During the Development Process, in: Randrup, Thomas Barfoed (ed).: Proceedings from the Urban Greening and Landscape Architecture research symposium. Proceedings no. 2-1999. Danish Forest and Landscape Research Institute, Hoersholm, 130 p.

Harris, R. W.; Matheny, N.; Clark, J.R.1999. Arboriculture: integrated management of landscape trees, shrubs, and vines. Third edition. Upper Saddle River, N.J.: Prentice Hall.

Jennings, N. E. 1978. Tree ordinances for small towns. National Urban Forestry Conference Proc. 1:743-745.

Johnson, G. 1999. Protecting Trees from Construction Damage: A Homeowner's Guide. Publication FO-6135-GO. St. Paul, MN: Minnesota Extension Service University of Minnesota. Available online at <http://www.extension.umn.edu/distribution/housingandclothing/DK6135.html>

Little, T. M.; Hills, F. J. 1972. Statistical methods in agricultural research. Berkeley, CA: University of California Public Services Offices.

Lobel, D. F. 1983. Managing urban forests using forestry concepts. Journal of Arboriculture 9(3):75-78.

Matheny, N; Clark, J. R. 1998. Trees and Development: A Technical Guide to Preservation of Trees During Land Development. Champaign, IL: International Society of Arboriculture. 183 p.

McPherson, E. G.; Johnson, C. W. 1988. A community forest planning process: case study of citizen participation. Landscape and Urban Planning 15:185-194.

McPherson, E. G. (submitted) Sacramento's parking lot shading ordinance: environmental and economic costs of compliance. Landscape and Urban Planning.

Miller, R. W. 1988. Urban forestry: planning and managing urban greenspaces. Prentice- Hall, Englewood Cliffs, NJ. 404 p.

Nowak, D. J.; Rowntree, R. A.; McPherson, E. G.; Sisinni, S. M.; Kerkmann, E. R.; Stevens, J. C. 1996. Measuring and analyzing urban tree cover. Landscape and Urban Planning 36: 49-57.

Peper, P.J.;Mori,S.M.;McPherson, E.G. (submitted) Predictive equations for dimensions and leaf area of San Joaquin Valley street trees. Tree Physiology.

Rossi, R. S. 1990. Oak ordinances: do they help or hurt? Fremontia 18(3):96-98.

Sommer, R. 1989. Householder response to street trees. Final report. Center for Consumer Research, Univ. of California, Davis, CA. 61 p.

Sommer, R.; Guenther, H.; Barker, P. A. 1990. Surveying householder response to street trees. Landscape Journal 9:79-85.

Schrock, D. S. 1996. Preventing Construction Damage to Trees. Publication G6885. Columbia, MO: University Extension, University of Missouri. Available online at <http://muextension.missouri.edu/xplor/agguides/hort/g06885.htm>

Scott, K.I., Simpson, J.R., and E.G. McPherson. 1999. Effects of tree cover on parking lot microclimate and vehicle emissions. Journal of Arboriculture 25(3): 129-142. Online at [http://wcufore.ucdavis.edu/effects\\_of\\_tree\\_cover\\_on\\_parking.htm](http://wcufore.ucdavis.edu/effects_of_tree_cover_on_parking.htm)

Sydnor, T. D. No date. The response of Ohio's native and naturalized trees to construction activity. Columbus, OH: The Ohio State University, Urban Forestry School of Natural Resources. (Article and online database) Available online at <http://www.ag.ohio-state.edu/~natres/const.htm>

Sydnor, T. D.; Heiligmann, R. B. No date (1999?) Trees and Home Construction: Minimizing the impact of construction activity on trees. Ohio State University Extension Bulletin 870-99. Online at <http://ohioline.ag.ohio-state.edu/b870/index.html>

Tschantz, B. A. and Sacamano, P.L. 1994. Municipal tree management in the United States. Davey Resource Group and Communication Research Associates, Inc. 58pp plus appendix.

Valentine, F. A.; Westfall, R. D.; Manion, P. D. 1978. Street tree assessment by a survey sampling procedure. Journal of Arboriculture 4(3):49-57.

World Forestry Center; Morgan, R. 1989a. An introductory guide to community and urban forestry in Washington, Oregon and California. World Forestry Center, Portland, OR. 25 p.

World Forestry Center; Morgan, R. 1989b. A technical guide to community and urban forestry in Washington, Oregon and California. Portland, OR: World Forestry Center. 49 p.

## **Additional References**

### **General**

Abbey, D. G.; Abbey, B. 1998. U.S. Landscape Ordinances : An Annotated Reference Handbook. New York: John Wiley & Sons.

Duerkson, C. 1993. Tree Conservation Ordinances. PAS 446. Chicago, IL: American Planning Association. 107 pp.

Louisiana State University School of Landscape Architecture "Green laws" web site  
<http://www.design.lsu.edu/greenlaws>

Grey, G. W. 1978. Tree ordinances and related policy. National Urban Forestry Conference Proc. 1:627-631.

Johnston, R. A.; Madison, M. E. 1991. Application of CEQA to protection of hardwood rangeland habitat. Div. of Environmental Studies, Univ. of California, Davis, CA. Prepared for: Forest and Rangeland Resource Assessment Program, California Department of Forestry and Fire Protection, Sacramento, CA.

National Arbor Day Foundation. Make your town a Tree City USA. Pamphlet. 6 p.

Tereshkovich, G., 1990. Texas Municipal Tree and Landscape Ordinances. Journal of Arboriculture 16(3):62-65.

Thurrow, C.; Toner, W.; Erley, D. 1975. Performance controls for sensitive lands: a practical guide for local administrators. Parts 1 and 2. Planning Advisory Service Reports 307, 308. American Society of Planning Officials, Chicago.

Weber, C. C. 1982. Developing A Successful Urban Tree Ordinance. In: Proceedings of the Second National Urban Forestry Conference. Reprinted version available online at <http://www.msue.msu.edu/msue/imp/moduf/07279528.html>

## **Dot grid estimation**

Barrett, J. P.; Philbrook, J. S. 1970. Dot grid estimates: precision by repeated trials. *Journal of Forestry* 68:149-154.

Gering, L. R.; Bailey, R. L. 1984. Optimum dot-grid density for area estimation with aerial photographs. *Journal of Forestry* 82:428-431.

Rowntree, R. A. 1984. Forest canopy cover and land use in four eastern United States cities. *Urban Ecology* 8:55-67.

## **Public Polling**

Dillman, D. A. 1978. *Mail and telephone surveys: the total design method*. Wiley, New York. 325 p.

Groves, R. M.; Kahn, R. L. 1979. *Surveys by telephone*. Academic Press, New York. 358 p.

Warwick, D. P.; Lininger, C. A. 1975. *The sample survey: theory and practice*. McGraw-Hill, New York. 344 p.